



KEMENTERIAN PENDIDIKAN TINGGI  
JABATAN PENDIDIKAN POLITEKNIK DAN KOLEJ KOMUNITI

**POLITEKNIK**  
MALAYSIA  
SULTAN MIZAN ZAINAL ABIDIN

**JILID 3**

# **DIGES**

## **PROJEK PELAJAR**

### **PROGRAM DIPLOMA**

#### **PSMZA 2023**

**UNIT PENYELIDIKAN, INOVASI & KOMERSIAL**  
**POLITEKNIK SULTAN MIZAN ZAINAL ABIDIN**

© Politeknik Sultan Mizan Zainal Abidin & Unit Penyelidikan, Inovasi & Komersial (UPIK).

Hak cipta terpelihara. Tiada bahagian daripada terbitan ini boleh diterbitkan semula, disimpan untuk pengeluaran atau ditukarkan ke dalam sebarang bentuk atau dengan sebarang alat sekalipun, sama ada dengan cara elektronik, gambar serta rakaman dan sebagainya tanpa kebenaran bertulis daripada Unit Penyelidikan, Inovasi dan Komersial, Politeknik Sultan Mizan Zainal Abidin, Dungun, Terengganu.



**Diterbitkan oleh / Published by:**

Politeknik Sultan Mizan Zainal Abidin,  
Unit Penyelidikan, Inovasi dan Komersial,  
KM 8, Jalan Paka. 23000 Dungun.  
Terengganu Darul Iman.  
Tel: 09-8400800  
Faks: 09-8458781  
Laman sesawang: <https://psmza.mypolycc.edu.my/>

Terbitan ini dikeluarkan secara tahunan

**April 2024**



# KATA ALUAN

HAJAH ZAMRA BINTI DERAHMAN

PENGARAH  
POLITEKNIK SULTAN MIZAN ZAINAL ABIDIN



**Assalamualaikum WBT, Salam Sejahtera dan Salam Malaysia MADANI,**

Dengan lafaz setinggi-tinggi kesyukuran ke hadrat Allah SWT kerana dengan izin dan kurnia-Nya, sekali lagi Unit Penyelidikan, Inovasi dan Komersial (UPIK), PSMZA berjaya menerbitkan Diges Projek Pelajar Program Diploma PSMZA, Jilid 3 2023. Penerbitan ini adalah satu wadah perkongsian ilmu secara terbuka kepada semua organisasi.

Kompilasi artikel yang dipilih adalah daripada kumpulan projek inovasi yang berjaya dengan cemerlang dalam program *Student Project Competition on Innovation and Invention Design* (SPEED). Ini bertepatan dengan fungsinya sebagai pemangkin yang memupuk budaya inovasi di kalangan pelajar dan pengajar di PSMZA.

Dengan berteraskan pelaksanaan projek pelajar secara *interdiscipline* bercirikan Revolusi Industri 4.0, terima kasih tidak terhingga kepada semua penyelia projek pelajar di PSMZA. Segala jerih perih dan sumbangan dalam membimbing projek pelajar adalah perlambangan kepada membudayakan lebih banyak produk pelajar mengikut perkembangan industri hari ini. Sekalung penghargaan juga kepada barisan sidang editor atas usaha mencapai Pelan Tindakan PSMZA dalam menerbitkan diges hasil penyelidikan dan inovasi pelajar PSMZA.

Adalah besar harapan saya agar penerbitan sebegini dapat memperkasa pemikiran generasi muda secara inovatif dan kreatif ke arah merealisasikan Revolusi Industri 4.0. Semoga segala usaha ini diberkati dan dirahmati Allah SWT.

**Sekian terima kasih.**



# KATA ALUAN

Ts. MOHYIDDIN BIN SALLEH

TIMBALAN PENGARAH  
POLITEKNIK SULTAN MIZAN ZAINAL ABIDIN



**Assalamua'laikum wbt, Salam Sejahtera & Salam Malaysia MADANI.**

Tahniah dan syabas diucapkan kepada Unit Penyelidikan, Inovasi & Komersial (UPIK) PSMZA di atas penerbitan Diges Projek Pelajar Program Diploma PSMZA 2023 ini. Penerbitan yang merupakan hasil daripada Program *Student's Project Competition Innovation and Invention Design* (SPEED 2023) ini, saya percaya akan memberikan impak yang baik dalam membina persekitaran inovasi di PSMZA.

Sekalung penghargaan dan tahniah diucapkan kepada semua pelajar dan penyelia projek pelajar semester akhir pada kali ini. Saya percaya, tidak mudah untuk menjayakan sesuatu. Tetapi, hasil tidak akan mengkhianati usaha. Apa yang kita usahakan hari ini, pasti akan mendapat ganjarannya suatu hari nanti.

Pelaksanaan projek pelajar bercirikan *Fourth Industrial Revolution* (4IR) merupakan salah satu daripada Teras 1 Pelan Transformasi PSMZA. Penerbitan diges ini merupakan bukti kejayaan pelaksanaan Program SPEED 2023 yang kita harapkan dapat menyuntik minat pelajar kepada 4IR. Ini akan membantu pelajar membina peluang pekerjaan yang lebih cerah apabila tamat pengajian nanti.

Akhir kata daripada saya, tahniah kepada semua yang terlibat dalam penerbitan diges ini. Semoga setiap usaha daripada kita semua akan mendapat keberkatan daripada Allah SWT.

**Sekian terima kasih.**



# KATA ALUAN

**PUAN NORFADHILAH BINTI HASAN**

**KETUA UNIT PENYELIDIKAN, INOVASI & KOMERSIAL  
POLITEKNIK SULTAN MIZAN ZAINAL ABIDIN**



**Assalamua'laikum wbt, Salam Sejahtera & Salam Malaysia MADANI.**

Alhamdulillah syukur ke hadrat Ilahi kerana dengan limpah kurniaNYA Diges SPEED 2023 ini dapat diterbitkan dengan jayanya. Tahniah diucapkan kepada para pelajar projek tahun akhir, para pensyarah penyelia, ahli jawatankuasa SPEED 2023, dan seterusnya semua editor yang terlibat dalam penerbitan diges ini.

Inisiatif untuk melibatkan pelajar dalam projek-projek yang berfokus pada *Fourth Industrial Revolution* (4IR) adalah langkah yang sangat positif dan relevan dengan perubahan semasa dalam dunia pendidikan dan industri. Inisiatif ini tidak hanya akan memberikan manfaat kepada institusi, tetapi juga membekalkan pelajar dengan keupayaan dan kecekapan yang relevan dalam menghadapi cabaran masa depan.

Pengiktirafan terhadap pelajar dan penyelia yang terlibat adalah satu bentuk motivasi yang amat berharga. Usaha mereka di dalam meneroka inovasi dan teknologi moden turut memberi harapan bahawa generasi muda kita memiliki potensi besar untuk berjaya dalam menghadapi cabaran global.

Diharapkan penerbitan diges ini dapat menjadi satu sumber inspirasi kepada semua pihak di PSMZA dan masyarakat setempat untuk terus menggalakkan perkembangan inovasi dan keusahawanan di kalangan pelajar. Semoga usaha bersama ini terus memberikan hasil yang memberangsangkan dan menjadi permulaan untuk pencapaian lebih besar di masa depan.

**Sekian terima kasih.**



# SIDANG EDITOR

## PENAUNG

HAJAH ZAMRA BINTI DERAHMAN

Pengarah

Politeknik Sultan Mizan Zainal Abidin

## PENASIHAT 1

Ts MOHYIDDIN BIN SALLEH

Timbalan Pengarah Akademik  
Politeknik Sultan Mizan Zainal Abidin

## PENASIHAT 2

NORFADHILAH BINTI HASAN

Ketua Unit Penyelidikan, Inovasi & Komersial  
Politeknik Sultan Mizan Zainal Abidin

## PENGERUSI

SUHAILA AZURA BINTI ABD SALAM

## KETUA EDITOR

NAJAH BINTI MOHD NAWI

## EDITOR

Ir Ts MOHD AZRIMAN BIN MAT ALI

Ts MUHD HASANUL ISYRAF BIN MAT JUNOH

Ts NOR AZIAH FATMA BINTI ABDUL AYAH @ ABDUL AZIZ

NOR FAIZAH BINTI ISMAIL

NOOR SYAHIDA BINTI SHAMSUDDIN

ROSLI BIN ABD AZIZ

## PANEL PENYEMAK DALAMAN

Dr MOHD ROSDI BIN SALLEH

Dr NORAZMIRA WATI BINTI AWANG

Dr AKASYAH BIN MOHD KHATRI

## PEREKA GRAFIK

ADE AZMAN BIN AHMAD

BIL	PROJEK PELAJAR & PENULIS	MUKASURAT
-----	--------------------------	-----------

1.	<b>Simulasi Pengawal Lampu Amber Berkelip untuk Amaran Awal Semasa Lengkung Mendatar</b> <i>Ahmad Naqeeb Eizran Bin Ahmad Humaizi, Mohamad Hambali Bin Marzuki, Che Ku Ahmad Aliff Bin Che Ku Alias</i>	1
2.	<b>Bluetooth Lawn Mower</b> <i>Norazlinawati binti Mat Yaacob, Muhammad Irfan Rafiq bin Bustaman</i>	8
3.	<b>Solar Tracking System (STS)</b> <i>Nur Hanee Afiqah Bt Mohd Rusmaizee, Nur Adlina Binti Mohd Rani</i>	14
4.	<b>Guard Anti - Sleep Cap</b> <i>Isamudin Bin Mamad, Nur Izzati Hanum Binti Romzie, Muhammad Izzat Bin Mohd Rasdi, Muhammad Afzan Hakimie Bin Nor'Azlan, Mohammad Akma Afiq Bin Aziz</i>	19
5.	<b>WCO Biodiesel Processing Reactor</b> <i>Muhammad Haiqal Azmi, Muhammad Azrol Mohd Jaafar, Muhammad Izzul Nizam Mohd Nazri, Muhammad Akmal Zikry Mohd Zamri, Mohd Hafizil Mat Yasin</i>	26
6.	<b>Mobile RFID Attendance Recorder Based on Arduino</b> <i>Hisyamsani bin Idris, Nik Izzul Farhan bin Nik Ghazali</i>	36
7.	<b>Mini EV Car</b> <i>Muhd Hasanul Isyraf Bin Mat Junoh, Ahmad Kharun Syazwan Bin Mat Khari, Muhammad Farieddin Bin Anuar, Muhammad Akmal Danial Bin Nasrudin, Muhammad Fakhrul Hadi Bin Hamidi</i>	43
8.	<b>Stargazer The Sound Insulation (SSI) For Los Angeles Resistance Abration (LA) Machine</b> <i>Nor Suriani Binti Mohd Nor, Nur Hidayatul Fatihah Bt Nor Mohairi, Nurmayuni Bt Kamurulzaman, Nur Azira Ruwaidah Bt Rosli, Nur Azrin Syafarina Bt Mohd Azlan</i>	53

9. **Designing and Developing Web Based System for E-Permit at Majlis Perbandaran Dungun**  
*Nor Azlina Binti Ibrahim, Muhammad Qaid Haziq Bin Mohd Iqbal, Najib Farhan Bin Faisal @ Ahmad Faisal, Muhammad Khairul Anuar Bin Johari* 61
10. **Folding Table Chair**  
*Mohd Sabri Bin Hussin, Daniel Essayue Idham Bin Abdullah, Muhammad Khairul Fakhri Bin Roslan, Muhammad Asraaf Bin Sulhaizam, Amirul Haziq Bi Zulkifli* 68
11. **EZ Grind Valve Machine**  
*Surniza Mohd Hilmin, Hafizul Razak, Haziq Firdaus Mohd Tarmizi, Iskandar Dzulkarnain Mohamad Fauzi, Muhammad Ammar Danial Norazmi* 76
12. **EQ Smart Counter – A Systematic Queue Device for Counter**  
*Noor Azlyn Ab Ghafar, Hasliza A Rahim @ Abd Rahim, Nur Alya Naqiah Md Akhir* 82
13. **Gas Tank Weight Scale**  
*Wee Siuw Sia, Muhammad Najmi Bin Mohd Zawawi* 87



# Simulasi Pengawal Lampu Amber Berkelip untuk Amaran Awal Semasa Lengkung Mendatar

**Ahmad Naqeeb Eizran Bin Ahmad Humaizi\*, Mohamad Hambali Bin Marzuki, Che Ku Ahmad Aliff Bin Che Ku Alias**

Department of Civil Engineering, Politeknik Sultan Mizan Zainal Abidin, 23000 Dungun Terengganu

\*Corresponding author E-mail: naqeeb2k3@gmail.com

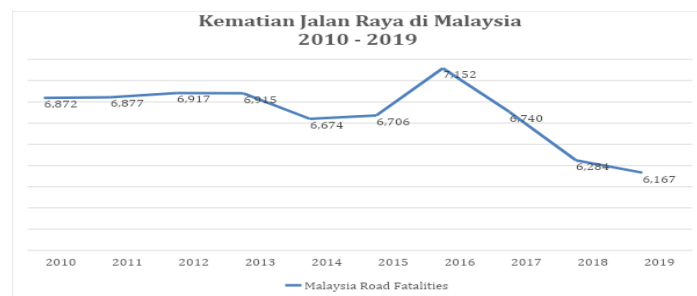
## Abstrak

Terdapat tiga (3) faktor yang telah dikenal pasti menyebabkan kemalangan, iaitu faktor manusia, kenderaan dan persekitaran. Kurang perhatian ketika memandu terhadap kenderaan yang berhenti di lorong kecemasan menyumbang kepada kemalangan. Kajian ini bertujuan untuk menghasilkan satu peranti keselamatan jalan raya dilaksanakan dalam simulasi skala makmal berorientasikan geometri selekoh tajam. Produk yang dihasilkan berorientasikan kepada Arduino Microcontroller Uno, membolehkan sensor mengesan pegun kenderaan di lokasi tertentu dan menyampaikan maklumat kepada pengawal mikro dalam tempoh 3 saat. Rel pengadang sedia ada bertindak sebagai alat kawalan lalu lintas untuk memberi amaran dengan memancarkan lampu berkelip (ambar) dan dikawal oleh sistem suria. Penilaian diambil melalui dua (2) kaedah iaitu maklumbalas pakar dan pengguna menggunakan dua (2) set Borang Soal Selidik yang berbeza. Daripada analisis peratusan mendapati bahawa ke semua responden bersetuju agar simulasi ini perlu dibangunkan di lokasi sebenar dan perlu dikomersilkan oleh agensi terlibat. Selain itu, dikemukakan juga beberapa penambahbaik daripada pakar agar peranti kawalan trafik ini berupaya memberi impak pengurangan kemalangan nyawa di Malaysia.

**Kata Kunci:** Lorong Kecemasan; Peranti Kawalan Traffik; Rel Pengadang

## 1. Pengenalan

Kadar kemalangan di Malaysia telah meningkat dalam tempoh 10 tahun. Melalui sumber yang dilaporkan oleh pihak PDRM, bilangan kematian akibat kemalangan jalan raya di Malaysia telah mencatatkan jumlah tertinggi bagi tempoh sembilan tahun, pada tahun 2016, dengan jumlah 7,152 kematian, dan jumlah terendah pada tahun 2018 dengan angka 6,284 kematian seperti rajah di bawah. Manakala dalam tempoh tiga tahun (2016-2018) jumlah penurunan sebanyak 12.1% telah direkodkan.



**Rajah 1.** Statistik kematian Jalan Raya di Malaysia 2010 - 2019

Sumber : laman web rasmi Kementerian Pengangkutan Malaysia

Di Malaysia, definisi kemalangan jalan raya menurut Laporan Perangkaan Kemalangan Jalan Raya Malaysia di dalam *Malaysian Institute of Road Safety Research*, suatu kejadian yang berlaku berpunca sama ada daripada kecuaiannya atau disebabkan oleh faktor persekitaran yang mengakibatkan pelanggaran dengan melibatkan sekurang- kurangnya sebuah kenderaan

yang bergerak dan berlaku kecederaan atau kematian. Sikap pengguna memainkan peranan penting kerana mereka berada di jalan raya dan berkongsi dengan pengguna lain. Keperihatinan dan kepekaan semasa memandu adalah sangat penting kepada sekeling berupaya untuk mengelak berlaku kemalangan. Menurut *Annual Report* Lembaga Lebu Raya Malaysia 2020, menunjukkan 82.37% faktor pengguna menjadi penyumbang tertinggi kadar kemalangan jalanraya, faktor persekitaran sebanyak 11.71% dan faktor kenderaan sebanyak 5.92%. Manakala faktor persekitaran terbahagi kepada faktor waktu kemalangan sebanyak 61.74% manakala 75.32% adalah faktor cuaca.

Walaupun tiada rajah yang tepat berkenaan statistik kemalangan di laluan kecemasan, namun kecelakaan ini tidak seharusnya berlaku. Kenderaan yang tiba-tiba rosak dan berhenti di laluan kecemasan turut meningkatkan kemalangan yang berlaku pada laluan kecemasan. Menurut Kaedah 53 dalam Kaedah-Kaedah lalu Lintas Jalan 1959 (LN166/1959), Akta Pengangkutan Jalan (1987) telah menjelaskan bahawa kegunaan lorong kecemasan hanya untuk kenderaan dalam tugas kecemasan sahaja. Selain dari kenderaan yang berhenti secara kecemasan di laluan tersebut. Namun begitu sering dibaca di dada-dada akhbar berkenaan berita kemalangan maut yang melibatkan kenderaan berhenti di laluan kecemasan. Dipetik dari Berita Harian *Online* bertarikh 18 Disember 2021, kejadian kemalangan maut yang membabitkan 10 orang telah berlaku di Lebu raya Elite pada 18 Disember 2021 yang membabitkan 10 maut. Ini adalah berikutan kenderaan yang rosak di laluan kecemasan yang melibatkan 3 kereta dan sebuah treler. Penglihatan yang terbatas terutama hari gelap atau ketika hujan lebat menyukarkan pemandu yang berada di laluan pemanduan. Matlamat projek jenis nyata ini dilaksanakan adalah untuk membantu para pengguna jalan raya agar lebih selamat ketika melalui selekoh tajam yang kerap berlaku kemalangan akibat kurang kepekaan. Untuk mencapai matlamat tersebut, terdapat 3 objektif perlu dipenuhi iaitu membangunkan prototaip simulasi di lokasi berisiko seperti di selekoh merbahaya pada skala makmal. Satu sistem peranti kawalan trafik berorientasikan kepada *Arduino Microcontroller Uno* dan sensor inframerah. Dengan ini satu simulasi kebolehfungsian produk dilaksanakan bagi menghasilkan persembahan data.

Kajian projek ini dapat membantu pihak syarikat konsesi Lebu raya seperti Lebu raya Pantai Timur, Jabatan Kerja Raya (JKR) dan Kerajaan Tempatan dalam menyediakan rangkaian lebuhraya, jalan persekutuan dan negeri yang selamat kepada para pengguna. Selain itu, ia juga dapat mengurangkan kadar kemalangan di jalanraya terutama di lokasi merbahaya pada waktu malam dan sewaktu hujan lebat yang menghadkan jarak penglihatan pengguna jalanraya, sekali gus dapat mencapai Petunjuk Prestasi Utama (KPI) Pelan Keselamatan Jalanraya Malaysia (PKJR) (2022), yang menetapkan pengurangan sebanyak 50% kemalangan jalanraya setiap tahun. Secara tidak langsung, manfaat projek ini adalah kepada pengguna jalan raya di mana ia dapat meningkatkan tahap keselamatan pengguna terutama mereka yang mengalami masalah kerosakan dan terpaksa berhenti di lorong kecemasan seperti di waktu malam atau cuaca hujan lebat.

Pengadang jalan ialah struktur jalan raya penting untuk menjamin keselamatan pengguna yang bertujuan menghalang kenderaan terkeluar dari laluan terutama apabila berlaku kemalangan. Dipetik daripada Arahan Teknik (Jalan) 1-85 *Manual on design guidelines of longitudinal traffic barrier* (1985), terdapat 4 jenis penghadang jalan yang selalu digunakan di Malaysia, iaitu tegar, separa tegar dan pengadang lentur serta pengadang baharu. Setiap satu pengadang berkenaan ada fungsi dan tujuan berbeza, serta begitu juga rekabentuk dan bahan digunakan yang juga tidak sama.

He, Y et al. (2023) menyatakan bahawa sistem kawalan berupaya mengelakkan pelanggaran aktif pada sesuatu laluan. Di Malaysia, pada kebiasaannya, lebuh raya menyediakan 4 lorong iaitu lorong kecemasan, lorong perlahan, lorong laju dan lorong memotong. Bahu jalan atau lebih dikenali sebagai lorong kecemasan ini disediakan khusus untuk tujuan kecemasan dan selenggara. Menurut kajian Safian et al. (2012), lorong kecemasan ini dikhaskan untuk kegunaan ambulans, bomba dan penyelamat, polis, agensi penguatkuasaan serta kenderaan yang rosak atau dalam situasi kecemasan. Dengan menggunakan lorong ini, ia dapat memudahkan pihak-pihak yang disebutkan di atas untuk sampai ke destinasi dengan lebih cepat tanpa perlu berdepan dengan aliran trafik yang sesak.

## 2. Metodologi/Reka Bentuk

### 2.1 Reka Bentuk Projek

#### 2.1.1 Kaedah/Prosedur/Teknik Penghasilan Projek

Kajian ini melibatkan penghasilan produk inovasi di mana ia dikategorikan peranti kawalan trafik. Peranti ini mampu mengesan kenderaan yang berhenti di laluan kecemasan akibat kenderaan rosak sementara menunggu bantuan seperti di lebuh raya. Satu jujukan nyalaan lampu berkelip akan dipasang pada penghadang jalan sebagai tanda isyarat kepada pemandu-pemandu yang lain yang melalui arah yang sama. Lokasi yang akan dijadikan zon pencerapan adalah di kawasan selekoh tajam atau laluan pendakian yang boleh menyebabkan tidak jelas atau tidak perasan kepada pemandu lain.

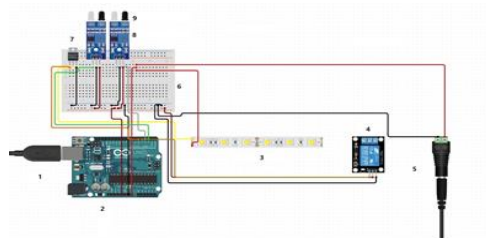
#### 2.1.2 Bahan dan Peralatan

##### a. *Arduino Microcontroller Uno*

*Arduino* adalah komuniti sumber terbuka perkakasan dan perisian komputer, projek dan pengguna. Alat ini dicipta bersama kit berasaskan *microcontroller* untuk mencipta peranti digital interaktif dan boleh mengesan dan mengawal objek kawalan dan dunia elektronik.

##### b. *Infrared Sensor*

Projek ini hanya untuk menghasilkan prototaip sahaja maka IR sensor adalah *device* elektronik yang amat sesuai digunakan. Ini kerana ia hanyalah skala makmal sahaja.



Rajah 2. Litar Schematic Projek

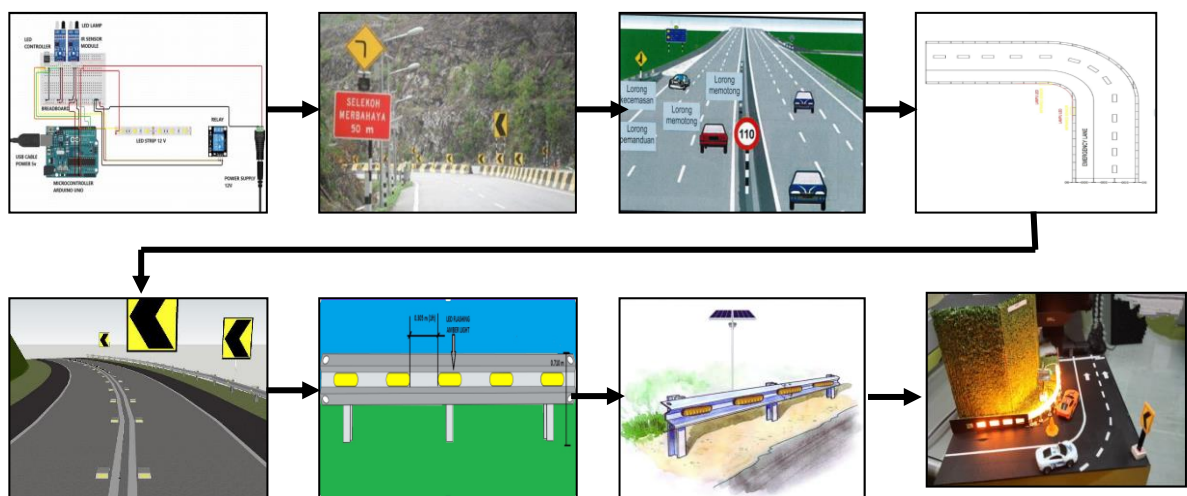
Pengesanan dibuat terhadap objek (kereta) yang menghampiri IR sensor selama 3 saat yang di nisbahkan kepada 30 saat di lokasi sebenar. Projek ini hanya untuk menghasilkan prototaip sahaja maka IR sensor adalah *device* elektronik adalah sesuai digunakan. Pengesanan dibuat terhadap objek (kereta) yang menghampiri IR *sensor* selama 3 saat yang di nisbahkan kepada 30 saat di lokasi sebenar. Alat ini akan dipasangkan dengan

set *Arduino* tetapi pendawaian yang terasing. Alat ini akan mengesan kehadiran pergerakan objek menghampiri penghadang jalan. Sebanyak 2 IR *sensor* dipasang pada model simulasi pada jarak tertentu.

c. Lampu LED

Lampu LED yang akan digunakan adalah di dalam lingkungan 12 watt dengan sambungan tambahan. Warna lampu yang akan digunakan adalah berwarna kuning dan berkelip-kelip sehingga objek teralih dari kedudukan yang dikesan. Ini kerana cahaya kuning (amber) memiliki beberapa keunggulan dibandingkan cahaya lain. Jika dibandingkan dengan cahaya merah atau biru, warna kuning memiliki cahaya yang lebih terang.

d. Prototaip



Rajah 3. Carta alir penghasilan model berskala makmal

Bahan yang akan digunakan untuk membina prototaip berskala makmal adalah seperti sebuah model di kawasan selekoh tajam jalan raya yang mempunyai penghadang jalan iaitu besi. Kedudukan sistem yang akan dipasang adalah sangat penting bagi melihat kekemasan serta fungsi yang baik. Penghalang bukit yang tinggi menampakkan keadaan sebenar dilebuh raya. Manakal laluan jalan adalah searah dan mempunyai 3 lorong utama.

2.1.3 Kaedah Analisis Data

Analisa data akan diambil dari segi keboleherjaan sistem pengesanan objek yang menggunakan IR *sensor* dan *Arduino*. Selain itu jujukan nyalaan lampu turut dilihat cara ia berfungsi agar dapat disedari oleh pemandu lain yang melaluinya. Dua set soal selidik iaitu kepada pakar yang terdiri daripada Lembaga Lebuhraya Pantai Timur (LPT2), Bahagian Jalan, Jabatan Kerja Raya Cawangan Dungun dan pensyarah pakar dalam bidang lalulintas dari Universiti Teknologi Mara (UiTM) dan set ke dua kepada pengguna jalan raya. Demostrasi dilakukan kepada semua responden bagi mendapatkan maklumbalas yang tepat dan telus.

### 3. Keputusan Dan Perbincangan

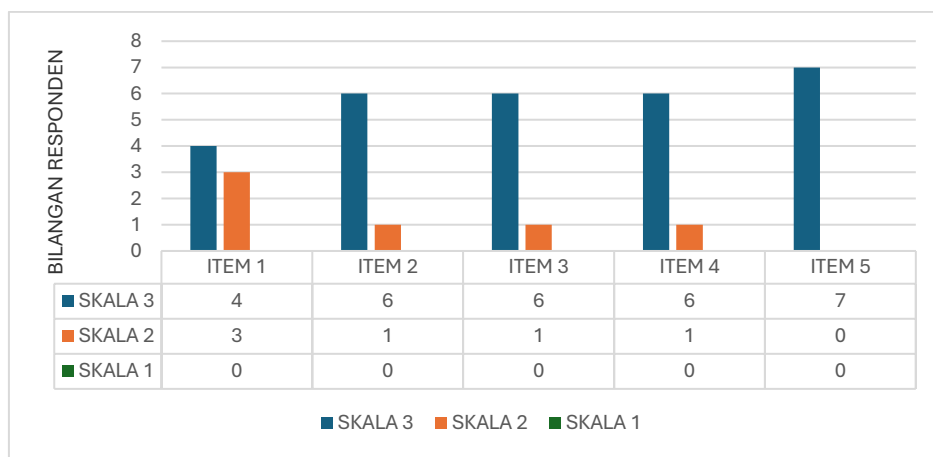
Berdasarkan borang selidik yang diedarkan kepada dua kumpulan responden iaitu kumpulan yang terdiri daripada pakar dalam bidang kejuruteraan lalu lintas seramai 7 orang, manakala pengguna jalan raya seramai 28 orang. Suatu data analisis dapat diambil dan perbincangan kajian dapat dikupas.

#### 3.1 Maklumbalas penilaian pakar

Jadual dibawah adalah skala kriteria yang perlu di lengkapkan oleh pakar berdasarkan 5 item.

**Jadual 1.** Skala kriteria serta penjelasan.

Skala	Kriteria	Penjelasan
3	Cemerlang	Ini bermakna projek inovasi yang dibangunkan merupakan idea yang sangat cemerlang dan memenuhi kriteria fasiliti keselamatan jalan raya kepada pengguna.
2	Memuaskan	Ini bermakna projek inovasi yang dibangunkan merupakan idea yang memuaskan dan kurang memenuhi kriteria fasiliti keselamatan jalan raya kepada pengguna.
1	Lemah	Ini bermakna projek inovasi yang dibangunkan merupakan idea yang sediada dan tidak memenuhi kriteria fasiliti keselamatan jalan raya kepada pengguna



**Rajah 4.** Carta bar bagi maklumbalas responden (pakar)

**Jadual 2.** Item-item dalam borang soal selidik kepada pakar

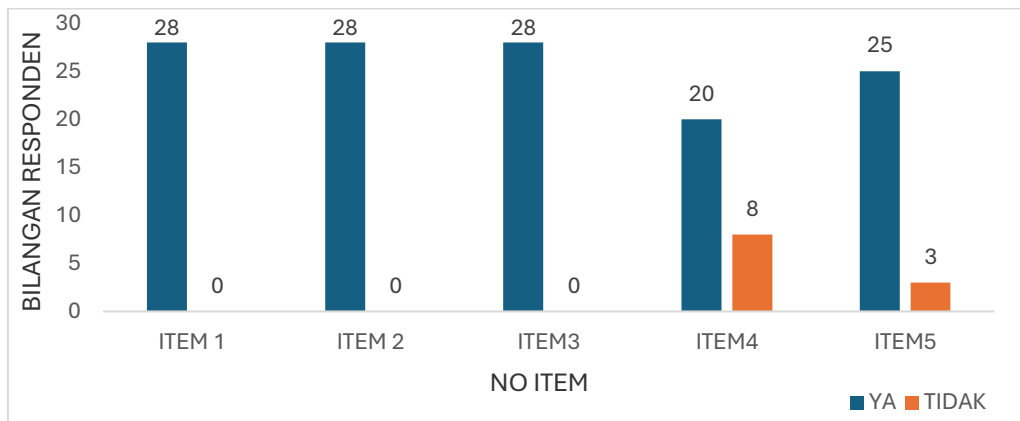
No Item	Item
1	Produk yang dihasilkan merupakan satu cadangan bagi mengurangkan kemalangan yang berlaku pada laluan kecemasan
2	Produk yang dihasilkan merupakan satu cadangan bagi amaran awal dengan lampu amaran yang berkelip untuk menarik perhatian kepada pemandu mengenai bahaya yang menunggu
3	Produk yang dihasilkan merupakan satu cadangan bagi meningkatkan kepekaan pemandu yang melalui kawasan bahaya yang tidak dapat dilihat dari posisi semasa seperti selekoh dan terhalang pemandangan terutama pada waktu malam atau hujan lebat.
4	Produk yang dihasilkan merupakan satu cadangan bagi mengurang dan mengawal kelajuan pergerakan kenderaan secara tersendiri kepada pemandu.
5	Produk yang dihasilkan merupakan satu cadangan bagi memenuhi Matlamat Pembangunan Mampan 2030 (SDG), mengurangkan separuh angka kematian dan kecederaan global akibat kemalangan jalan raya. (SDG3:3.6_ Kesihatan yang Baik dan Sejahtera)

Daripada keseluruhan cadangan dan komen dari pihak pakar terhadap konsep dan idea ini adalah mencadangkan agar sistem ini perlu digabungkan dengan sistem notifikasi kepada

pusat kawalan atau pengguna terutama untuk tindakan yang lebih cepat dan segera oleh pihak berkenaan. Selain itu skop pemasangan di lokasi sebenar perlu perisian agar tidak berlaku vandalisme pada pemasangan atau pelanggaran daripada kenderaan lain. Dari skop pemasangan dicadangkan juga untuk mendapatkan inisiatif tambahan pemasangan selain daripada *guard rail* sebagai pilihan ke dua seperti pada *road stud*. Maka konsep dan idea ini merupakan titik awal bagi tambahan idea yang lebih baik jika ia dipasang di lokasi sebenar.

### 3.2 Maklumbalas penilaian pengguna jalan raya

Borang soal selidik kepada pengguna jalan raya dinilai melalui Skala *Guttman* (YA/TIDAK) yang terdiri daripada 5 item.



Rajah 5. Carta bar bagi maklumbalas responden (pengguna jalan raya)

Jadual 3. Item-item dalam borang soal selidik kepada pengguna jalan raya

No Item	Item
1	Produk Inovasi Yang Dihasilkan Berupaya Mengurangkan Kemalangan Yang Berlaku Pada Laluan Kecemasan
2	Produk inovasi ini adalah bertindak untuk amaran awal dengan lampu amaran yang berkelip untuk menarik perhatian kepada pemandu mengenai bahaya yang menunggu
3	Produk yang dihasilkan berupaya meningkatkan kepekaan pemandu yang melalui kawasan bahaya yang tidak dapat dilihat dari posisi semasa seperti selekoh dan terhalang pemandangan terutama pada waktu malam atau hujan lebat.
4	Produk yang dihasilkan merupakan satu cadangan bagi mengurang dan mengawal kelajuan pergerakan kenderaan secara tersendiri kepada pemandu
5	Model simulasi ini merupakan satu cadangan yang sesuai untuk digunakan pada lokasi sebenar

Pengguna menunjukkan respon yang amat baik terhadap sistem kawalan yang boleh diaplikasikan di kawasan sebenar. Konsep dan idea yang diketengahkan berupaya mengurangkan kadar kemalangan pada lokasi yang dikaji serta suatu inovasi dalam teknologi peranti kawalan trafik yang tidak memerlukan kos yang agak tinggi.

### 4. Kesimpulan

Daripada maklumbalas yang diperolehi, konsep dan idea ini merupakan suatu idea yang baru dan wajar untuk dilaksanakan pada lokasi yang sebenar. Ia merupakan suatu produk yang membantu menambahkan isyarat amaran kepada kenderaan datang dari arah belakang untuk berwaspada atas faktor kecemasan. Produk ini juga sangat bagus dengan memberi amaran awal kepada pemandu lain dan halangan objek yang terdapat di lebuhraya.

Pelaksana projek ini adalah suatu inisiatif ke arah tindakan yang diambil bagi mencapai *Sustainable Development Goals* menjelang 2033. Di mana konsep dan idea ini antara platform bagi mencapai matlamat 3 iaitu memastikan kehidupan yang sihat dan menggalakkan kesejahteraan untuk semua pada semua peringkat umur adalah penting untuk pembangunan mampan. Manakala matlamat 11 perkara 11.2 di mana menjelang 2023, peranti kawalan trafik ini mampu mencapai target dalam meningkatkan keselamatan jalan raya.

Dengan ini, ia adalah satu alternatif dalam usaha pihak terlibat mengurangkan peratus kemalangan yang disebabkan oleh pemandu dan juga faktor persekitaran. Kesimpulan yang dapat di ambil adalah ia merupakan sebuah projek yang berjaya dengan cetusan idea yang cukup cemerlang.

## Rujukan

- Annual Report 2020* Lembaga Lebuhraya Malaysia (2021). Lembaga Lebuhraya Malaysia.
- Akta Pengangkutan Jalan (1987). *Road Traffic Rules* LN 166/59 (1959). Undang-undang Malaysia.
- Arahan Teknik (Jalan) 1/85. *Manual On Design Guidelines of Longitudinal Traffic Barrier* (1985), Roads Branch Public Works Department Malaysia Jalan Sultan Salahuddin 50582 Kuala Lumpur.
- Asean Road Safety. (n.d.). *Kajian Pengurusan Keselamatan Jalan Raya*. Institut Penyelidikan Keselamatan Jalan Raya Malaysia.
- He, Y., Feng, J., Wei, K., Cao, J., Chen, S., & Wan, Y. (2023). Modeling and simulation of lane-changing and collision avoiding autonomous vehicles on superhighways. *Physica A: Statistical Mechanics and its Applications*, 609, 128328.
- Manual Fasiliti Keselamatan Jalan (2014). Cawangan Kejuruteraan Jalan dan Geoteknik, Jabatan Kerja Raya Malaysia.
- Indeks Kematian Jalan Raya Malaysia (2010-2019) (2020), Retrieved Jun 13,2023, from <https://www.mot.gov.my/my/land/safety/malaysia-road-fatalities-index>
- Indikator Matlamat Pembangunan Mampan (2019). In Portal Jabatan Perangkaan Malaysia Retrieved September 29 ,2023, from chrome extension://efaidnbmnnnibpcajpcglclefindmkaj/<https://www.ekonomi.gov.my/sites/default/files/2021-02/Sustainable-Development-Goals-%28SDG%29-Indicators-Malaysia-2019.pdf>
- Pelan Keselamatan Jalan Raya Malaysia 2022-2030 (2022). Kementerian Pengangkutan Malaysia.
- Safeek Affendy & Amirul Aiman (2021 Disember 18). 10 maut dalam kemalangan tiga kereta, treler di lebuhraya ELITE. BH online. <https://www.bharian.com.my/berita/nasional/2021/12/900149/10-termasuk-9-beranak-maut-dalam-kemalangan>.
- Safian, Noorliana and Mohd Sabri, Nurul Hanis and Kamarudina, Nurul Akma and Haris, Siti Melinda and Hussain, Shawal Sahid (2012) *Bandar selamat: satu kajian literatur* , 3rd *International Conference on Public Policy and Social Science ( ICOPS 2012)*. Faculty of Administrative Science and Policy Studies, Melaka, pp. 1-10. ISBN 978-967.

## Bluetooth Lawn Mower

Norazlinawati binti Mat Yaacob\*, Muhammad Irfan Rafiq bin Bustaman

Department of Electrical Engineering, Politeknik Sultan Mizan Zainal Abidin, 23000 Dungun Terengganu

\*Corresponding author E-mail: azlinawati@psmza.edu.my

### Abstract

Traditional lawn mowers are usually used to mow the lawn manually, but in the current development of technology, we have seen the use of bluetooth in various devices and applications. This innovative device leverages Bluetooth technology, specifically the HC-05 module, to show seamless communication between the mower and a smartphone. The user can effortlessly control various aspects of the lawn mower remotely, enhancing convenience and operational efficiency. The Bluetooth Lawn mower uses a smartphone as a control tool, which uses bluetooth (HC-05) as a communication signal (Tx & Rx). It is easy to move because it has four wheels and avoids noise pollution because it uses batteries. The user can control the operation and speed of the lawn mower remotely. Users can turn the machine on or off or change the cutting direction without having to be close to the lawn mower. This allows the user to control and keep the lawn mower more effectively. Preliminary studies show that the use of Bluetooth technology in lawn mowers provides many benefits to users. It improves the comfort and usability of the lawn mower, making it easier to run and monitor. In addition, users can also manage machine operations more efficiently, helping them save time and energy. Besides this user can set the height of the blade of the grass. In the future, we expect further developments in the use of bluetooth technology in lawn machines. This includes functional and performance improvements, integration with smart home systems, and the possibility of using other technologies such as GPS trackers for various applications.

**Key Words:** lawn mower, bluetooth, Arduino, smartphones, remotely, control operation, speed, direction

### 1. Introduction

A lawn mower, also known as a grass cutter, is a device equipped with rotating blades or a reel designed to trim a grass surface to an even height. The height of the cut grass is typically adjustable by the operator, either through a single expert lever or a mechanism on each wheel of the machine. These blades are manually controlled, mechanically connected to the cutting blades so they rotate when the mower is pushed forward, or by a battery-powered or plug-in electric motor. Commonly, internal combustion engines serve as the primary power source for lawn mowers, with smaller models requiring manual propulsion and larger ones being self-propelled or ride-on types. According to Rajesh, Preeti Oswal, Janhvi (2019), in current days, grass cutter machines are operated by fuel and electrical energy which are costly and requires high maintenance.

The Bluetooth lawn mower introduces an innovative approach to lawn care by operating autonomously or under the control of a remote operator. Employing Bluetooth technology, this mower is designed to enhance convenience and efficiency. Traditional lawn mowers, while widely used, pose safety concerns as the operator can be at risk of harm from the spinning blades, and achieving a consistent grass height relies heavily on the operator's skill. Thus, there is a need for a control system to ensure safe operation and uniform grass cutting.

The proposed Bluetooth lawn mower integrates hardware components such as the Arduino Uno microcontroller, HC-05 Bluetooth module, WIFI module, and four DC 12-volt motors for wheel propulsion. Utilizing Bluetooth and WIFI connections, this machine can operate without manual intervention, allowing control through Android devices. Battery-powered and equipped with wireless connectivity, the Bluetooth Lawn Mower concept aims to streamline lawn maintenance, offering users the flexibility to operate and monitor the machine remotely. This



innovative technology represents a significant leap forward in the evolution of lawn care machinery, providing a safer and more efficient alternative for users.

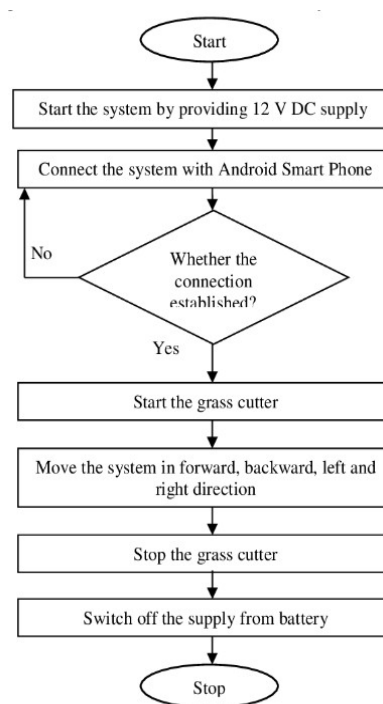
## 2. Methodology

### 2.1 Flow Chart

Figure 1 shows flowchart of the process Bluetooth Lawn Mower. The operational sequence of the Bluetooth Lawn Mower unfolds with a straightforward yet essential commencement. Users start the system by supplying a 12Vdc power source, infusing the mower with the necessary energy to embark on its lawn care duties. Following this crucial step, users seamlessly connect the mower with their Android smartphone, setting up a wireless link that serves as the linchpin for remote control functionality.

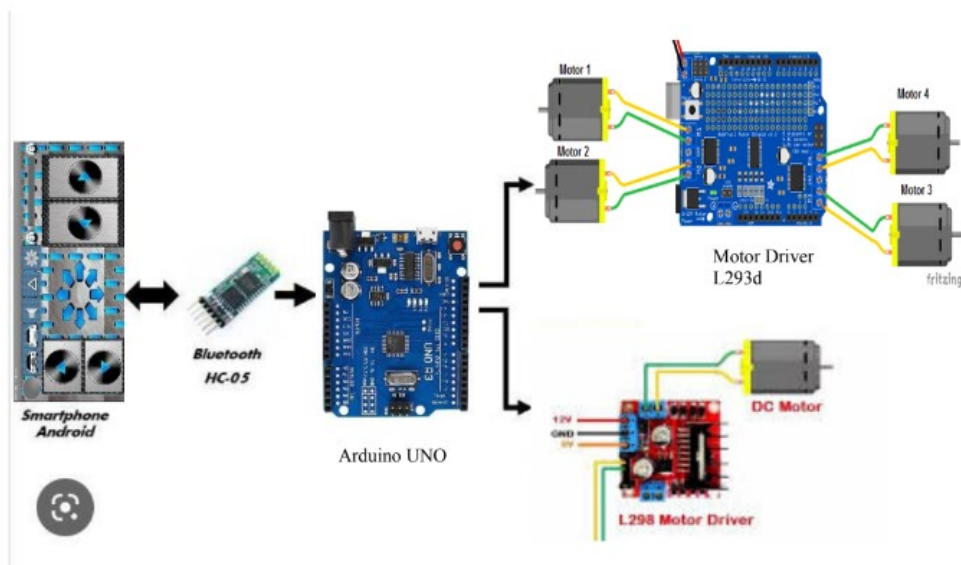
Upon a successful connection between the mower and the smartphone, users gain the ability to remotely activate the grass cutter through the smartphone interface. This marks the commencement of the grass-cutting task, with users wielding control over the mower's movements. The smartphone becomes a versatile control panel, allowing users to command the system to move forward, backward, left, and right, ensuring precise and tailored lawn coverage.

Once the grass-cutting operation is complete the user must stop the blade operation and switch off the supply from battery. Users can effortlessly bring the system to a halt by stopping the grass cutter through the smartphone interface. To conclude the entire process, users execute the last step switching off the power supply from the battery. This deliberate and systematic shutdown ensures the safety and conservation of energy resources. In summary, the Bluetooth Lawn Mower not only redefines the user experience in lawn care through its wireless control capabilities but also introduces a simplified yet sophisticated process that aligns with contemporary expectations of convenience and efficiency.



**Figure 1: Flowchart of the process Bluetooth Lawn Machine**

## 2.2 Block Diagram



**Figure 2: Block Diagram of Bluetooth Lawn Machine**

Figure 2 is the role of the part for the proposed project. Arduino Uno microcontroller, functioning as the central processing unit orchestrating the mower's various operations. The HC-05 Bluetooth module serves as a crucial communication bridge, facilitating wireless connectivity between the Arduino and an Android smartphone. This smartphone, armed with a dedicated app, acts as the user interface, empowering individuals to wirelessly control the mower's functionality. Through the Bluetooth connection, users can seamlessly send commands and receive real-time data, optimizing the mowing process. The integration of motor drivers adds a layer of sophistication to the system, translating digital commands into physical movements. These motor drivers link to the individual motors that drive the mower's wheels, allowing precise control over its forward, backward, left, and right movements. This cohesive integration of components in the block diagram underscores the efficiency and user-centric design of the Bluetooth Lawn Mower, where the interaction between Arduino, Bluetooth, smartphone, and motor drivers harmonizes to redefine the landscape of modern lawn care technology.

## 2.3 Project Design

### 2.3.1 Mechanical Design

The design of Bluetooth Lawn Mower is intricately tied to the overarching objective of crafting a compact and lightweight lawn machine. In pursuit of this goal, meticulous material research has led to the selection of plywood as the primary construction material. Plywood stands out for its structural stability, uniform strength, and resilience against water damage. These inherent qualities make plywood an ideal choice for constructing a lawn mower, ensuring the machine's durability and longevity while aligning seamlessly with the project's emphasis on minimizing weight. The deliberate choice of plywood not only addresses the practical considerations of structural integrity but also reflects a conscientious approach to selecting materials that contribute to the overall efficiency and effectiveness of the Bluetooth Lawn Mower. Figure 3 is the final model of the Bluetooth Lawn Mower. This design considers the factors of durability, safety, and effectiveness of the produced machine system. Figure 4 is a view of the bottom showing the position of

the blade that will cut the grass. Strategically positioned at the lower part of the mower, this blade is the focal point of the machine's functionality. Designed with precision and durability in mind, the cutting blade configured to cut the grass and even trim to the grass surface. Its specific placement ensures that it reaches the desired height, as dictated by user settings or adjustments.

Crafted from durable materials, the cutting blade is resilient and capable of withstanding the rigors of regular use. Its sharp edges, meticulously designed for optimal cutting efficiency, contribute to the overall effectiveness of the lawn mower. The thoughtful consideration given to the positioning of the cutting blade, as depicted in Figure 4.



**Figure 3: Final Model of Bluetooth Lawn Mower**



**Figure 4: Bottom View**

### 3. Result and Discussion

This Bluetooth Lawn Mower has features that allow users to connect their mobile devices such as smartphones or tablets to the lawn mower. By using the provided application, the user can control the operation of the lawn mower remotely. For example, they can turn the machine on or off or change the cutting direction without having to be close to the lawn mower. This allows the user to control and support the lawn mower more effectively. The concept of Bluetooth Lawn Mower involves integrating Bluetooth technology into lawn mower to enable wireless connectivity, control, and monitoring. This innovation can be controlled by the smartphone properly is less than 20 metres. If the lawn mower more than 20 metres from the smartphone, it will stop moving. The advantages of this Bluetooth Lawn Mower, the user only needs to control the operation of the machine through a smartphone. Apart from that, this lawn machine is lighter compared to existing lawn machines.

Table 1 shows the result for experiment 1 which is this innovation can move properly in smooth surface. The mower may encounter challenges when navigating rocky areas. Despite its advanced sensor technology, there may be instances where the mower gets stuck or faces difficulty in such rough terrain. In these situations, users are alerted through the mobile application, allowing them to intervene and guide the mower manually or make necessary adjustments to overcome obstacles. Despite occasional challenges in rocky areas, the Bluetooth Lawn Mower still maintains its adaptability and efficiency on a majority of surfaces, providing a solution that seamlessly transitions between terrains while prioritizing user convenience and overall effectiveness.

**Table 1:** Types of working surface

Types Of Working Surface	Mobility
Smooth surface	Can move smoothly and properly
Rocky surface	Get stuck or faces difficulty in such rough terrain

### 4. Conclusion

In conclusion, the development and design of the Bluetooth Lawn Mower, incorporating Arduino connectivity to a smartphone, marks a significant stride in modernizing lawn care practices. The aim of creating a compact and lightweight mower, distinct from existing models in the market, has been successfully achieved. This innovation not only addresses the evolving technological landscape but also directly benefits users by offering a convenient and efficient solution for lawn maintenance. The seamless integration of Arduino and smartphone control not only simplifies operation but also enhances user safety by minimizing physical exertion during grass cutting. By providing a user-friendly and technologically advanced alternative, this project contributes to making lawn care more accessible and manageable, lightening the burden for users and promising a safer and more efficient approach to the traditional task of mowing the lawn.

## References

- Rajesh Raikwar, Preeti Oswal, Janhvi Urganlawar (2019)-Bluetooth Controlled Lawn Mower  
<http://proceeding.conferenceworld.in/AEM-2019/34PYYs35wBc145.pdf>
- Ajibola, Olawale & Olajide, Sunkanmi & Osunde, Davidson. (2019). Design and Construction of Automated Lawn Mower.
- B.Sai Yashwanth, G.Srinivas Yadav, K.Sai Deepak, G.Srikanth. (2020). Automatic Lawn Mower <https://www.jetir.org/papers/JETIR2005444>
- Vipul Patel, Tanvi Patil, Pratik Sarvankar, Kashif Shah. Arduino Controlled Lawn Mower. IJSRD - International Journal for Scientific Research & Development| Vol. 3, Issue 11, 2016 | ISSN (online): 2321-0613 <https://www.academia.edu/20826831>
- A. Konwar, "A Technical Review of Lawn Mower Technology," 2016. [Online]. Available: <https://www.researchgate.net/publication/29655586>
- Neha, Syeda Asra. Automated Grass Cutter Robot Based on IOT. International Journal of Trend in Scientific Research and Development (IJTSRD) ISSN: 2456-6470 (PDF) Automated Grass Cutter Robot Based on IoT

## Solar Tracking System (STS)

Nur Haneefah Bt Mohd Rusmaizee\*, Nur Adlina Binti Mohd Rani

Department of Electrical Engineering, Politeknik Sultan Mizan Zainal Abidin, 23000 Dungun Terengganu

\*Corresponding author E-mail: haneefah28@gmail.com

### Abstract

Solar energy is a renewable energy that is very effective in the process of generating electricity. The existence of Solar Power Plants in Malaysia is like a mushroom growing after the rain today. Since Malaysia is moving towards the use of New Energy by 2025, the "Tracking Solar System (STS)" project was developed to respond to the call of the Malaysian Government in general and the Energy Commission (ST) in particular. This STS project uses ATmega238p Arduino Uno as a microcontroller and LDR (Light Dependent Resistor) to detect the light intensity at every 30° angle reading by using the Single Axis Tracking method horizontally to get the maximum light intensity while providing the maximum electricity generation results. This STS project was also developed based on the development of Teaching Aids for the Fundamental of Renewable Energy (DEG30013) course. This project has been adopted by the Electrical Engineering Department (JKE), Sultan Mizan Zainal Abidin Polytechnic (PSMZA) as one of the teaching aids for the course. A pilot test was conducted on 135 students who took the DEG30013 Course in Session 1:2023/2024 to enable it to be used in JKE, PSMZA. The results of the test show that the level of student acceptance of the STS Project as the teaching aid is very high at 97% acceptance.

**Key Words:** Solar Tracking, Renewable Energy, LDR

### 1. Introduction

Solar power generation has been used as renewable energy for years ago. Residential that uses solar power as their alternative power supply will bring benefits to them. The main objective of this paper is to present the development of an automatic solar tracking system whereby the system will cause solar panels to keep aligned with the Sunlight to maximize harvesting solar power. The system focuses on the controller design whereby it will cause the system is able to track the maximum intensity of Sunlight is hit. When the intensity of Sunlight is decreasing, this system automatically changes its direction to get maximum intensity of Sunlight. LDR light detectors act as a sensor used to trace the coordinate of the Sunlight by detecting brightness level of Sunlight.

STS is a Single-axis solar tracking system that follows the solar by moving in a single axis (vertical or horizontal). Generally, the inclination angle is adjusted manually at certain intervals during the year and automatic movement is provided in the east–west direction. Single-axis systems are more cost-effective than two-axis systems. Single-axis solar tracking systems are moved on the vertical or horizontal axis depending on the solar trajectory.

Studies have shown that the angle of light affects a solar panel's power output. A solar panel that is exactly perpendicular to the Sun produces more power than a solar panel that is not perpendicular. Small angles from perpendiculars have a smaller effect on power output than larger angles. In addition, the Sun angle changes north to south seasonally and east to west daily. As a result, although tracking east to west is important, north to south tracking has a less-significant impact.

Solar trackers provide significant advantages for renewable energy. With solar tracking, power output can be increased by about 30 to 40 percent. The increase in power output promises to open new markets for solar power.

Light intensity provides good output on the production of effective electricity. The use of existing solar panels that are in a fixed position and do not move. They contribute to the production of minimal and ineffective electricity. This problem can be overcome by using the Solar Tracking System (STS). This project is a prototype of the actual solar energy generation used in today's Solar Power Plant.

The second problem is to diversify teaching aids for courses involving Renewable Energy such as the Fundamental of Renewable Energy (DEG30013) course at Polytechnic Malaysia. This Solar Tracking System project can be used as one of the additional teaching aids to show the actual observation process of solar energy such as the actual process in a Solar Power Generation Plant.

## **2. Literature Review**

Based on the research by M. Karthik et al. (2018) in the project on Smart Solat Tracking System says one of the most important concerns around the world is the energy crisis. A potential solution to this problem is renewable energy. In recent years, solar panels have been used more frequently to convert solar energy into electricity. It is affordable and almost completely safe for the environment. Electromagnetic radiation used to generate electricity is released by it. The goal is to develop a deployable autonomous solar tracking system that moves the solar panels so that they remain perpendicular to the sun. In this system, the sensor will be a photoresistor. The horizontal and vertical axes of the dual axis solar panel are rotated, so that the efficiency of the device can be increased. Thus, the dual axis provides precise control of the planet's altitude relative to the sun. This will give the panel more efficiency.

Meta Yantidewi et al. (2020) says since solar energy is an infinite source of energy, it can be used as a suitable alternative energy source. One of the 5 technological attempts to utilize solar energy is the use of solar panels. A solar panel is a device consisting of a series of solar cells that can convert sunlight energy into electrical energy. The generated electrical energy adjusts the intensity of the received sunlight. However, in its application, most solar cells are statically placed (not following the movement of the sun), where the position of the solar panels only leads to one specific prevention of optimal absorption of the intensity of sunlight and resulting electrical energy generation. Therefore, we need a solar tracking system that can automatically control the solar panels to track the movement of the sunlight so that they can absorb the sunlight optimally. The solar tracker created in this research consists of monocrystalline solar panels, LDRS, INA219 sensor, Arduino board, and servo motors. Data collection was carried out for six hours on three consecutive days. According to this study, the greatest difference in power generated by solar panels occurs between 12:00 and 13:00 with an average value of active solar tracker power of 0.5 W and static solar tracker value of 0.34 W.

### **2.1 Photovoltaic Technology**

K. Chon et al. (2009) says solar cells are the best-known technique for producing electrical power through Silicon Cells swaddle in photovoltaic modules. to elucidate the photovoltaic solar panel more easily, photons from sunlight energies electrons in an upper state of energy and coming to the lower state to release one electron so that creating electricity. The term photovoltaic defines the general unbiased working condition of a photodiode in which current through the appliance is due to the transduced light energy. Solar cells generate direct current electricity from light, which can be used to recharge a battery for electric devices.

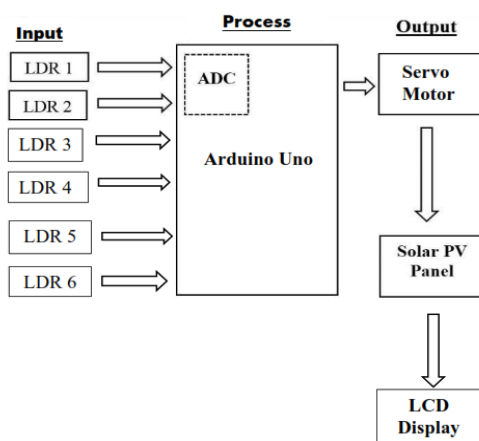
## 2.2 Solar Tracker Fundamentals

Radwan et al. (2020) says a solar tracker is a device for aligning a day lighting reflector, solar photovoltaic panel or concentrating solar reflector or lens toward the sun. The sun's position in the sky varies with the seasons (elevation) even with the time of day as the sun moves across the sky. Solar-powered devices function best when every time pointed at the sun, so a solar tracker will hike the effectively of devices over any confirmed position, at the cost of extra system complexity. There are several kinds of solar trackers, of different charges, quality, and performance. Some best-known type of solar tracker is the heliostat, a movable mirror which reflects the moving sun to a fixed position, but several other techniques will be used as well. The efficiency of the solar tracker depends upon the application, concentrators, in particular solar cell processes, require an intensity of exactness to ensure that fact that saturated sunlight is directed exactly to the devices, that is at (or near) the focal point of the reflector. Usually, concentrator techniques won't work without tracking, so at slightest single-axis tracking is necessary. Sizeable power plants or high-temperature resources research facilities using multiple ground-mounted mirrors along with an absorbent spot need with high accuracy like that used for solar telescopes.

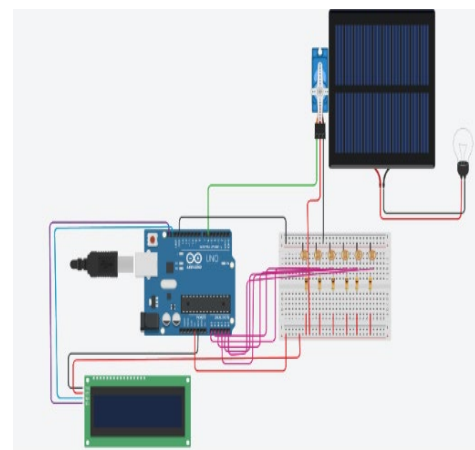
## 2.3 Single Axis Solar Tracker

K. Aygul et al. (2019) A single-axis solar tracker continues to follow the movement of the sun either horizontally or vertically. As the name recommends, this sort of tracker seems to have just one axis for rotary motion. The horizontal variety of solar trackers is utilized in tropical regions where the sun will receive very way up at midday, except the days are going to be short. On the other hand, the upright kind of solar tracker is employed in regions with elevations where the sun doesn't have to get high, but summer days are often lengthy. In concentrated solar power processes, single-axis trackers are going to be used with flat surface solar module.

## 3. Solar Tracking System Block Diagram and Schematic Diagram



**Figure 1:** Block Diagram of STS



**Figure 2:** Schematic Diagram of STS



## 4. Result and Acknowledgement

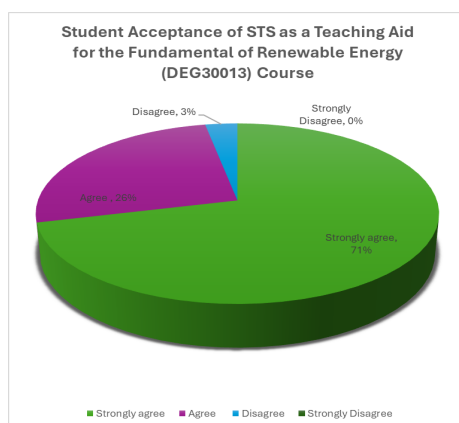
### 4.1 Result

A survey was distributed to 135 students enrolled in the DEG30013(Fundamental of Renewable Energy) course to assess the usability of the Solar Tracking System (STS) in practical implementation for the course. The results of the pilot test showed that out of the 131 students who responded, they agreed that the product could be used as a teaching aid for Course DEG30013. The STS has also obtained approval for use from the Head of the Electrical Engineering Department for implementation in teaching and learning activities for the course in alignment with the established syllabus. **Figure 4** and **Figure 5** illustrate the results of the pilot test and the approval for usage by the Head of the Electrical Engineering Department at PSMZA.

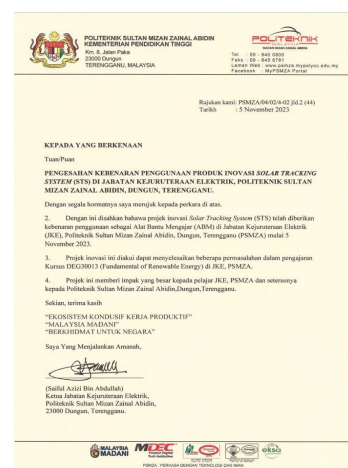


**Figure 3:** Solar Tracking System (STS)

### 4.2 Acknowledgement



**Figure 4:** Student Acceptance of STS



**Figure 5:** Confirmation Letter by Head of Electrical Engineering Department PSMZA

## 5. Conclusion

The Solar Tracking System project is an innovation in the field of Renewable Energy. It is a technology that allows solar panels to follow the movement of the sun throughout the day. With the successful development of this project, there are various market potential and entrepreneurial opportunities that can be obtained. Among them, the production of electricity through this solar system is safe and does not pollute the environment and can help reduce negative and bad effects on the environment. In addition, it also can improve energy efficiency by ensuring that solar panels receive maximum sunlight, leading to higher energy production than existing systems. STS also can be used as a Teaching Aid for the DEG30013 (Fundamental of Renewable Energy) Course at Polytechnic Malaysia and can be used as a prototype in parallel with the actual solar energy generation method in the workplace. Indirectly, students will better understand the topic of Solar Energy theoretically and practically as preparation for entering the real world. With the achievement of 97% acceptance level, this project has been approved for use by the Head of the Electrical Engineering Department, Polytechnic of Sultan Mizan Zainal Abidin to be used as a teaching aid in the coming semester.

## References

- K. Aygul, M. Cikan, T. Demirdelen, & M. Tumay (2019). *Butterfly Optimization Algorithm Based Maximum Power Point Tracking of Photovoltaic Systems Under Partial Shading condition*. United Kingdom. Energy Sources, Part A Recover. Util. Environ. Eff., vol.00, no. 00, pp. 1–19.
- K. Chon & C. Wong (2009). *General Formula for On-axis Sun-tracking System and Its Application in Improving Tracking Accuracy of Solar*. Kuala Lumpur. Research Gate Tunku Abdul Rahman University.
- Meta Yantidewi, Brilliyani Hadid & Dzulkifli (2020). *Arduino-based Dual Axis Solar Tracking System*. Surabaya. Department of Physics, Universiti Negeri Surabaya, Indonesia.
- M.Karthik, R. Vishnu, M. Vigneshwar & M.Logaeshwar (2018). *Smart Solar Tracking System*. Uttar Pradesh. 5th IEEE International Conference on Electrical, Electronics and Computer Engineering (UPCON).
- Radwan & Y. A. R. I. Mohamed (2020). *Grid-Connected Wind Solar Cogeneration Using Back-to-Back Voltage-Source Converters*. United Kingdom. IEEE Trans. Sustain. Energy, vol. 11, no. 1, pp. 315–325.

## Guard Anti – Sleep Cap

**Isamudin bin Mamad\*, Nur Izzati Hanum binti Romzie, Muhammad Izzat bin Mohd Rasdi, Muhammad Afzan Hakimie bin Nor' Azlan, Mohammad Akma Afiq bin Aziz**

Department of Electrical Engineering, Politeknik Sultan Mizan Zainal Abidin, 23000 Dungun Terengganu

\*Corresponding author E-mail: isamudin@psmza.edu.my

### Abstrak

Guard Anti-Sleep Cap merupakan inovasi yang bertujuan mengatasi masalah kecenderungan individu mengalami keletihan dan kehilangan kewaspadaan dalam tempoh kerja. Penyataan masalah merujuk kepada risiko kecelakaan dan penurunan produktiviti akibat pengabaian terhadap tugas pengawasan disebabkan tanda-tanda mengantuk. Objektif utama projek ini adalah untuk mengurangkan risiko mengantuk berlebihan. Projek ini dapat mengesan serta memberikan peringatan mengantuk kepada pengguna terutamanya pengawal keselamatan secara efektif. Dengan menggunakan teknologi canggih termasuk Arduino Nano, penderia Infa Red, buzzer, motor getaran mini, dan bateri, Guard Anti-Sleep Cap berfungsi dengan mengesan kelopak mata tertutup melalui penderia infra-red. Selepas satu saat isyarat diproses di Arduino Nano yang bertindak sebagai pengawal utama proses. Isyarat yang diproses dihantar kepada item keluaran iaitu isyarat bunyi (mini buzzer) dan isyarat getaran (motor getaran mini). Kesimpulannya, Guard Anti-Sleep Cap memberikan penyelesaian menyeluruh untuk meningkatkan kewaspadaan dan keselamatan pengguna dalam aktiviti pengawalan berterusan. Projek ini dikuasakan dengan Bateri 12 Volt dan amat kurang risiko keselamatan elektrik.

*Kata kunci: Arduino Nano, Penderia Infra-Red, Mini Buzzer, Motor Getaran Mini*

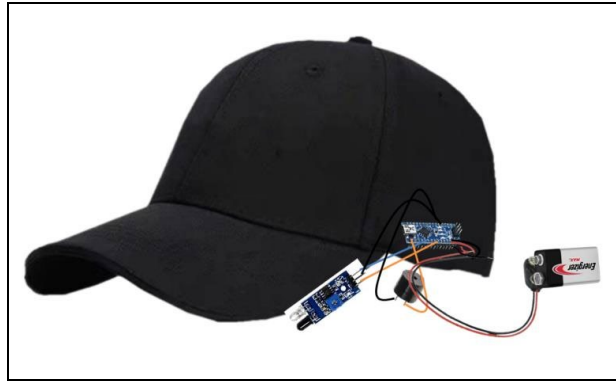
### 1. Pengenalan

Isu lazim berkisar tentang kecenderungan yang wujud individu untuk mengalami rasa mengantuk atau kewaspadaan berkurangan semasa bekerja dalam jangka waktu berpanjangan. Keadaan ini menimbulkan risiko besar kepada keselamatan dan produktiviti. Oleh itu, terdapat keperluan untuk penyelesaian yang dapat mengesan tanda-tanda mengantuk secara berkesan dan mengeluarkan amaran tepat pada masanya kepada pengguna, serta menangani cabaran kritikal untuk mengekalkan kewaspadaan semasa tempoh aktiviti yang panjang.

#### 1.1 Perincian Projek

Projek Guard Anti-Sleep Cap adalah satu inovasi yang direka untuk membantu mngurangkan rasa mengantuk dan meningkatkan kewaspadaan pada individu yang menghadapi tempoh kerja Panjang di mana pada kebiasaanya tempoh pengawal keselamatan bertugas adalah di antara 8-12 jam sehari. Ini akan menyebabkan badan merasa letih dan juga mengantuk. Justeru itu projek inovasi ini dibangunkan untuk membantu mengawal rasa mengantuk.

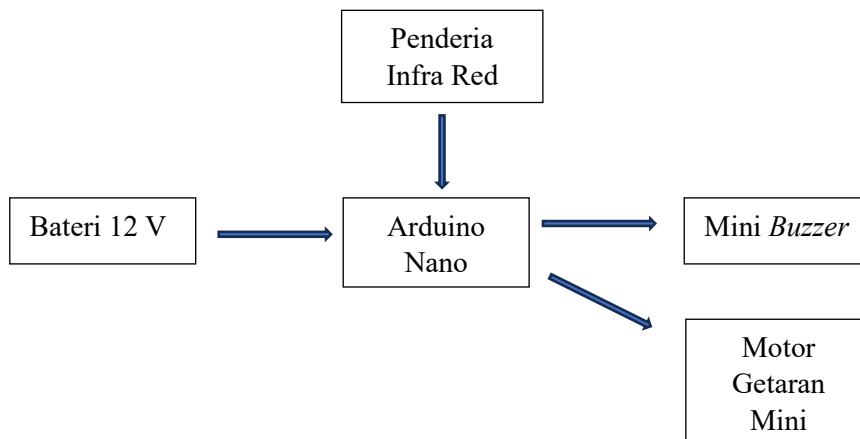
Ia memanfaatkan teknologi canggih dengan menggabungkan penderia yang memantau aktiviti gelombang otak pemakai dan mengesan tanda mengantuk dengan berkesan. Komponen projek ini termasuk Arduino Nano, penderia IR, mini buzzer, suis SPST, motor getaran mini dan bateri. Arduino Nano berperanan sebagai mikropengawal yang mengawal sensor IR dan buzzer. Penderia IR digunakan untuk mengesan halangan seperti kelopak mata tertutup, manakala buzzer memberi isyarat audio kepada pengguna. Motor getaran bertujuan untuk memberikan peringatan tambahan kepada pengguna tanda-tanda mengantuk dikesan. Suis SPST menghidupkan atau mematikan 19 sistem, manakala bateri 12V menyediakan kuasa kepada kesemua komponen.



**Rajah 1:** Gambar rajah projek

Rajah 1 menunjukkan gambaran keseluruhan Guard Anti-Sleep Cap yang dibangunkan. Ia juga dapat dilihat kedudukan keseluruhan komponen yang digunakan dalam projek ini.

### 1.2 Blok Diagram Projek



**Rajah 2:** Gambar rajah Blok Diagram Projek

Rajah 2 menunjukkan blok diagram keseluruhan projek di mana dapat menggambarkan kedudukan bagi komponen atau modul yang digunakan. Anak panah yang menunjukkan kea rah Arduino nano menggambarkan penderia *infra red* dan bateri sebagai masukan. Manakala anak panah yang keluar dari Arduino nano menunjukkan keluaran bagi projek ini iaitu mini *buzzer* dan motor getaran mini.

#### **Penderia Infra Red:**

Ia adalah peranti elektronik yang digunakan untuk mengesan beberapa objek persekitaran berhampiran. Ia mengesan pergerakan sesuatu objek. Dalam projek ini kami menggunakan Penderia Infra Red sebagai input untuk mengesan kedipan mata.

#### **Arduino Nano:**

Ia adalah papan Pengawal Mikro. Ia digunakan untuk sokongan teknikal, di mana kod program diprogramkan ke dalamnya dan ia berfungsi sebagai pengawal fungsi.

#### **Mini Buzzer:**

Mini *Buzzer* digunakan sebagai komponen keluaran isyarat bunyi untuk pengguna tersedar daripada mengantuk.

### Motor Getaran Mini:

Motor Getaran Mini juga komponen keluaran yang memberi isyarat getaran sebagai tambahan kepada isyarat bunyi.

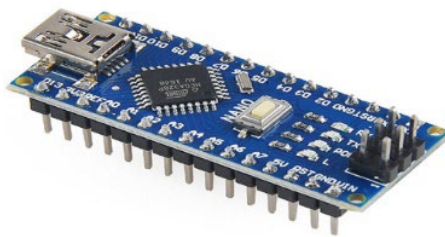
## 2. Komponen Perkakasan

Bagi melengkapkan projek ini, beberapa komponen yang penting diperlukan seperti Arduino Nano yang bertindak sebagai mikropengawal yang memproses isyarat masukkan daripada penderia dan menghantar isyarat kepada komponen keluaran iaitu mini *buzzer* dan motor getaran mini.

### 2.1 Pengenalan Kepada Arduino Nano

#### 2.1.1 Arduino Nano

Arduino Nano seperti rajah 3, adalah kecil dan lengkap yang bersiri ATmega328P dikeluarkan pada tahun 2008. Ia menawarkan sambungan yang sama dan spesifikasi papan Arduino Uno tetapi dalam faktor bentuk yang lebih kecil. Arduino Nano dilengkapi dengan 30 tapak masukan dan keluaran (I/O), dalam konfigurasi seperti DIP-30, yang boleh diprogramkan menggunakan Perisian Arduino pembangunan persekitaran bersepadu (IDE), Papan litar boleh dikuasakan melalui kabel mini-USB jenis-B atau daripada bateri 12 V. Walaupun saiznya kecil, Arduino Nano memuatkan lebih kurang ciri yang sama seperti Arduino UNO. Jika anda membandingkan UNO dan Nano, maka Nano tidak mempunyai Bicu Kuasa DC dan mengandungi penyambung USB jenis mini-B. Selain itu Nano sangat serupa dengan UNO dari segi fungsi. Papan Nano direka bentuk sedemikian rupa sehingga pin adalah mesra pengguna supaya boleh memasangnya dengan mudah sesuatu projek yang ingin dibangunkan. Secara keseluruhan, Arduino Nano adalah alternatif yang terbaik untuk digunakan dalam projek ini kerana fungsinya standing UNO dan juga boleh didapati dengan harga yang lebih rendah selain saiznya lebih kecil dan bersesuaian dengan projek.



**Rajah 3:** Gambar rajah Arduino Nano

#### 2.1.2 Penderia *Infra Red*

Penderia *Infra Red* seperti rajah 4, ialah peranti elektronik yang memancarkan cahaya untuk mengesan beberapa objek di sekeliling. Penderia *Infra Red* boleh mengukur haba objek serta mengesan gerakan. Biasanya, dalam spektrum inframerah semua objek memancarkan beberapa bentuk sinaran terma. Jenis sinaran ini tidak dapat dilihat oleh mata kita, tetapi penderia inframerah boleh mengesan sinaran ini. Pemancar hanyalah LED IR dan pengesan hanyalah fotodiod IR. Fotodiod adalah sensitif kepada cahaya IR dengan panjang gelombang yang sama yang dipancarkan oleh LED IR. Apabila cahaya IR jatuh pada fotodiod, rintangan dan voltan keluaran akan berubah mengikut perkadaran dengan magnitud cahaya IR yang diterima. Terdapat lima elemen asas yang digunakan dalam sistem pengesanan inframerah biasa: sumber inframerah, medium

penghantaran, komponen optik, pengesan atau penerima inframerah dan pemrosesan isyarat. Laser inframerah dan LED inframerah dengan panjang gelombang tertentu digunakan sebagai sumber inframerah. Tiga jenis media utama yang digunakan untuk inframerah penghantaran adalah vakum, atmosfera dan gentian optik. Komponen optik digunakan untuk memfokuskan inframerah sinaran atau untuk menghadkan tindak balas spektrum.



**Rajah 4 :** Gambar rajah Penderia *Infra Red*

### 2.1.3 Mini Buzzer

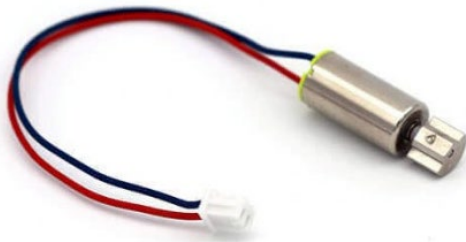
Mini *Buzzer* seperti rajah 5, menghasilkan bunyi berdasarkan terbalik kepada kesan piezoelektrik. Generasi daripada perubahan tekanan atau terikan dengan penggunaan elektrik potensi merentas bahan piezo elektrik adalah asasnya prinsip. Mini *Buzzer* ini boleh digunakan memberi amaran kepada pengguna tentang peristiwa yang sepadan dengan tindakan pensuisan, isyarat balas atau input penderia. Ia juga digunakan dalam litar penggera. Mini *Buzzer* menghasilkan bunyi bising yang sama tanpa mengira variasi voltan yang digunakan padanya. Ia terdiri daripada piezo kristal antara dua konduktor. Apabila potensi itu digunakan merentasi kristal ini, mereka menolak pada satu konduktor dan tarik pada yang lain. Ini, tolak dan tarik tindakan, hasilnya dalam gelombang bunyi. Kebanyakan buzzer menghasilkan bunyi dalam julat 2 hingga 4 kHz. Plumbum merah disambungkan ke input dan plumbum hitam disambungkan ke bumi pada papan Arduino Nano.



**Rajah 5:** Gambar rajah Mini *Buzzer*

### 2.1.4 Motor Getaran Mini

Motor getaran mini seperti rajah 6, mempunyai dua wayar merah dan hitam. Merah ialah wayar positif manakala hitam ialah wayar untuk disambungkan ke bumi. Voltan kerja bagi motor getaran ialah 2 hingga 5 volt. Voltan terkadar ialah 3.7 volt dan arus ialah 0.07 amp yang sama dengan 70mili-amp.



**Rajah 6:** Gambar rajah Motor Getaran Mini

### 2.1.5 Bekalan Kuasa

Bekalan kuasa seperti rajah 7 bagi projek ini ialah bateri 12V, di mana bateri ini dapat membekalkan voltan sehingga 12 Volt. Voltan sebenar yang digunakan dalam litar berukuran 7.2V hingga 9.6 V. Jadi untuk projek ini bateri 12 Volt digunakan dan memadai dengan bekalan kuasa yang diinginkan. Selain itu bateri ini bersaiz lebih kecil dan mudah ditukar ganti.



**Rajah 7:** Gambar rajah Bateri

### 2.1.6 Suis SPST

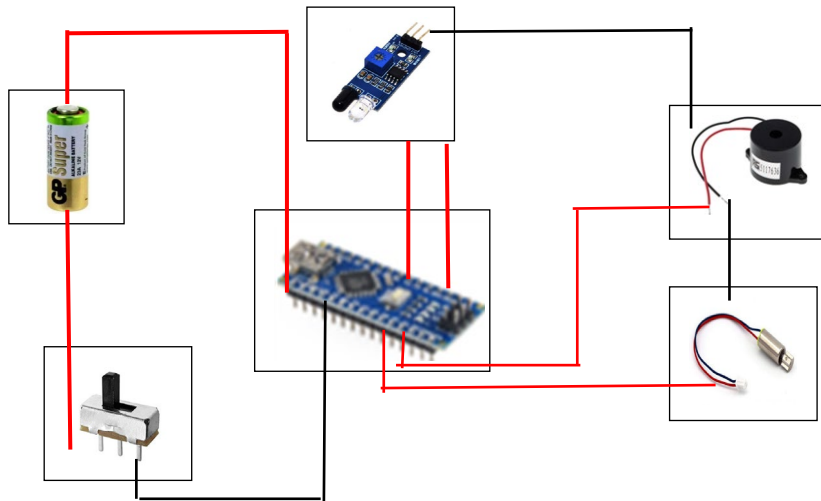
Spst Suis Lontaran Tunggal Tiang Tunggal seperti rajah 8 hanyalah suis dua terminal ringkas yang membantu memutuskan sambungan terminal satu ke terminal lain.



**Rajah 8:** Gambar rajah Suis SPST

### 3. Metodologi

#### 3.1 Rajah Litar



**Rajah 9:** Gambarajah Litar Projek

Rajah 9 menunjukkan gambarajah litar projek yang dibangunkan. Ia juga dapat dilihat kedudukan keseluruhan komponen yang digunakan dalam projek ini.

#### 3.2 Prosedur

Prosedur projek seperti di bawah:

- i. Menyambungkan semua komponen seperti yang ditunjukkan seperti Rajah 9.0.
- ii. Kod yang diperlukan diprogramkan ke dalam Arduino Nano menggunakan Arduino IDE dengan menyambungkan kabel USB ke komputer riba atau komputer.
- iii. Bekalan kuasa diberikan kepada litar dengan bantuan bateri 12V.
- iv. Penderia IR digunakan untuk mengesan mata berkelip atau mata tertutup seseorang, jika mata terpejam seketika dalam 1 saat buzzer dihidupkan secara automatik.
- v. Motor getaran Mikro dihidupkan serentak dengan buzzer.
- vi. Buzzer secara automatik dimatikan, apabila orang itu kembali ke keadaan normalnya.
- vii. Motor getaran Mikro dihidupkan serentak dengan buzzer.

Projek ini berfungsi setelah suis dihidupkan, dan apabila mengesan mata berkelip atau mata tertutup dalam 1 saat, penderia menghantar isyarat. Buzzer dan motor getaran secara automatik dihidupkan, dan apabila mata kembali ke keadaan normalnya, Buzzer dan motor getaran dimatikan.

### 4. Keputusan

Projek *Guard Anti-Sleep Cap* berfungsi dengan baik selepas diuji di mana dapat membantu dalam mengurangkan atau mencegah pengawal keselamatan mengantuk ketika menjalankan tugas mengawal. Kami percaya bahawa model projek kami memberikan kesan yang baik untuk menambah kualiti kerja-kerja keselamatan. Pada masa akan datang kami akan menggunakan kamera mikro yang akan menggantikan sensor mata dan akan memasukkan modul GPS dalam peranti untuk menjejaki lokasi pengawal keselamatan. Memandangkan kos barangan yang sangat berpatutan, projek ini boleh dipasarkan pada masa hadapan. Projek ini dapat mengesan kelopak mata tertutup dan penggera akan bertindak dengan cepat apabila terima isyarat (semasa dalam tidur). Projek *Guard Anti-Sleep Cap* merupakan item mudah



alih dan ia boleh digunakan dalam aplikasi yang berbeza seperti contoh memandu kereta diwaktu malam dan juga memandu dalam jangka masa yang Panjang bagi mengelakkan berlakunya *microsleep*.

## 5. Kesimpulan

Projek ini "penggera anti tidur untuk pemandu" berjaya direka bentuk, dan diuji. Matlamat projek ini adalah untuk membangunkan peranti yang boleh mengesan pekerja pengawal keselamatan daripada mengantuk dengan tepat dan memberi isyarat penggera dengan sewajarnya, yang bertujuan untuk menghalang pekerja terus tidur. Projek ini boleh membezakan diantara mata normal berkelip dengan mengantuk. Projek ini juga mampu dipasarkan ke pasaran kerana nilai tambahnya adalah menguntungkan.

## Rujukan

- Amol M. Malla, Paul R. Davidson, Philip J. Bones, Richard Green and Richard D. Jones, *Automated Video-based Measurement of Eye Closure for Detecting Behavioral Microsleep* presented at 32nd Annual International Conference of the IEEE EMBS Buenos Aires, Argentina, August 31 -- September 4,2010.
- D.Jayanthi, M.Bommy. *Vision-based Real-time Driver Fatigue Detection System for Efficient Vehicle Control*. In: International Journal of Engineering and Advanced Technology (IJEAT) ISSN: 2249 - 8958, Volume-2, Issue-1, October 2012.
- <https://www.academia.edu/34469825/A> [https://nevonprojects.com/driver-anti-sleep-device/Survey\\_Paper\\_On\\_Drowsiness\\_Detection\\_and\\_Alarm\\_System\\_for\\_Drivers](https://nevonprojects.com/driver-anti-sleep-device/Survey_Paper_On_Drowsiness_Detection_and_Alarm_System_for_Drivers)

## WCO Biodiesel Processing Reactor

Muhammad Haiqal Azmi<sup>1</sup>, Muhammad Azrol Mohd Jaafar<sup>1</sup>, Muhammad Izzul Nizam Mohd Nazri<sup>1</sup>, Muhammad Akmal Zikry Mohd Zamri<sup>1</sup>, Mohd Hafizil Mat Yasin<sup>2\*</sup>

<sup>1</sup>Department of Mechanical Engineering, Politeknik Sultan Mizan Zainal Abidin, 23000 Dungun Terengganu

<sup>2</sup>Center for Internal Combustion Engine and Powertrain System (CICEPS), Automotive Technology Center (ATeC), 23000 Dungun Terengganu

\*Corresponding author E-mail: hafizil@psmza.edu.my

### Abstract

With the increasing demand for sustainable energy sources, waste cooking oil (WCO) has emerged as a viable feedstock for biodiesel production. This study focuses on designing, fabricating, and analyzing the functionality of a biodiesel processing reactor specifically tailored for converting waste cooking oil into biodiesel. The reactor design incorporates efficient mixing, heat transfer, and catalyst utilization to enhance the transesterification process. Experimental investigations evaluated the reactor's performance under varying operating conditions, including reaction temperature, residence time, and catalyst concentration. The results for the volume of suction per minute (ml/min) for various fluid types indicate that the pump can deliver the highest amount of water compared to other fluids including biodiesel (18.9%), cooking oil (66.9%), and waste cooking oil (70.2%). This is because water has a lower viscosity compared to other oil-based fluids. This proposed reactor design exhibits notable advantages regarding biodiesel yield and purity. The study concludes with recommendations for scaling up the reactor design for commercial production, emphasizing its role in promoting sustainable and eco-friendly biodiesel production practices.

**Key Words:** *Waste cooking oil (WCO), biodiesel, reactor, pump analysis, suction rate*

### 1. Introduction

Increasing uncertainty about global energy production and supply, environmental concerns due to the use of fossil fuels, and the high price of petroleum products are the major reasons to search for alternatives to petrol and diesel. Lean claimed that the global supply of oil and natural gas from conventional sources is unlikely to meet the growth in energy demand over the next 25 years. In this perspective, considerable attention has been given to the production of biodiesel as a diesel substitute. Moreover, biodiesel fuel has become more attractive because of its environmental benefits because plants vegetable oils, and animal fats are renewable biomass sources. Biodiesel represents a largely closed carbon dioxide cycle (approximately 78%), as it is derived from renewable biomass sources. Compared to petroleum diesel, biodiesel has lower emission of pollutants, biodegradable enhances the engine lubricity, and contributes to sustainability. Biodiesel has a higher cetane number than diesel fuel, no aromatics, no sulfur, and contains 10–11% oxygen by weight. Biodiesel, which is accepted as an attractive alternative fuel, is prepared by transesterification of vegetable oils and animal fats with alcohol in the presence of a catalyst. Biodiesel is a renewable and sustainable alternative fuel that is produced from a variety of sources, including vegetable oils, animal fats, and recycled cooking oils. It is a clean-burning fuel that can be used in diesel engines with little or no modification and has lower emissions of harmful pollutants compared to traditional diesel fuel. The introduction of biodiesel as a fuel source has been driven by several factors, including concerns about the environmental impact of traditional fossil fuels, the desire to reduce dependence on foreign oil, and the need to create new markets for agricultural products. Biodiesel is considered a promising alternative fuel because it is renewable, domestically produced, and has a lower carbon footprint than traditional fossil fuels.

Biodiesel can be used in a variety of applications, including transportation, power generation, and heating. It is typically blended with traditional diesel fuel in various ratios, depending on the desired performance and emissions characteristics. The use of biodiesel has grown significantly in recent years, with many countries implementing policies and incentives to encourage its use. However, there are still challenges to overcome, including the availability of feedstocks, the cost of production, and the need for infrastructure to support its distribution and use. However, the land use to produce edible oil for biodiesel feedstock competes with the use of land for food production. Moreover, the price of edible plant and vegetable oils is usually higher than petrol and diesel. The use of waste cooking oil as biodiesel feedstock reduces the cost of biodiesel production since the feedstock costs constitute approximately 70-95% of the overall cost of biodiesel production. Hence, the use of waste cooking oils and non-edible oils should be given higher priority over edible oils as biodiesel feedstock. The use of neat (unprocessed) vegetable oils in compression ignition engines is reported to cause several problems due to its high viscosity.

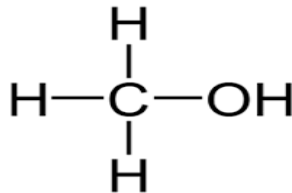
An important issue surrounding waste cooking oil is its improper disposal and its negative impact on the environment. When cooking oil is discarded incorrectly, such as being poured down the drain or thrown in the regular trash, it can have several detrimental effects such as environmental pollution, water contamination, and damage to infrastructure. Therefore, to address the issue of waste cooking oil, proper disposal methods should be followed such as recycling, collection programs, and solidification and disposal. Proper education and awareness campaigns can also play a significant role in informing individuals about the importance of responsible disposal and the potential consequences of improper waste cooking oil management. By adopting environmentally friendly practices and supporting recycling initiatives, we can minimize the negative impact of waste cooking oil on our environment and infrastructure (Thushari & Babel, 2022). Several factors contribute to the generation and improper disposal of waste cooking oil. These factors include household cooking, the food service industry, lack of recycling infrastructure, lack of awareness and education, convenience and habits, lack of regulation and enforcement, alternative uses, and recycling opportunities. Addressing these factors requires a combination of efforts from individuals, businesses, governments, and recycling organizations. Increased awareness campaigns, education about proper disposal methods, the establishment of recycling infrastructure, and the enforcement of regulations can all contribute to reducing the amount of waste cooking oil and ensuring its responsible management (Kezia Angeline et al., 2020).

Transesterification is a widely used method to convert waste cooking oil into biodiesel, a renewable and environmentally friendly fuel. This process involves chemically reacting the oil with an alcohol, typically methanol or ethanol, in the presence of a catalyst to produce biodiesel and glycerin as a byproduct. Here's an overview of the transesterification process:

- i. **Filtering:** The waste cooking oil is first filtered to remove any solid particles or impurities. This step helps ensure the quality of the final biodiesel product and prevents clogging or damage to the equipment.
- ii. **Pre-treatment:** Depending on the quality and condition of the waste cooking oil, pre-treatment may be necessary. This can involve removing water content, free fatty acids, and other contaminants that may interfere with the transesterification process. Pre-treatment methods include heating and drying the oil or using acid or base catalysts.

- iii. **Mixing:** The pre-treated cooking oil is then mixed with alcohol (methanol or ethanol) in a specific ratio, typically 3:1 to 6:1 oil to alcohol, depending on the desired conversion efficiency.
- iv. **Catalyst Addition:** A catalyst is added to the mixture to speed up the transesterification reaction. Common catalysts include sodium hydroxide (NaOH) or potassium hydroxide (KOH), which are alkali catalysts, or acid catalysts such as sulfuric acid (H<sub>2</sub>SO<sub>4</sub>).
- v. **Reaction:** The mixture is heated and stirred for a certain period, typically several hours, to facilitate the reaction. During this time, the triglycerides in the waste cooking oil react with alcohol in the presence of the catalyst, resulting in the formation of biodiesel and glycerin.
- vi. **Settling:** After the reaction, the mixture is allowed to settle. Glycerin, which is denser, separates from the biodiesel and settles at the bottom of the container.
- vii. **Separation:** The glycerin layer is separated from the biodiesel, usually by decanting or using a centrifuge. The glycerin can be further processed for other applications or disposed of properly.
- viii. **Washing and Drying:** The biodiesel is then washed with water or other agents to remove any remaining impurities or traces of catalyst. After washing, the biodiesel is dried to remove any water content.
- ix. **Quality Testing:** The final biodiesel product is tested for various parameters such as viscosity, flash point, and acidity to ensure it meets the required specifications and standards.

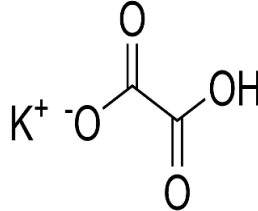
Transesterification provides an effective method to convert waste cooking oil into a valuable fuel source, reducing dependence on fossil fuels and minimizing environmental impact. However, it's important to note that the transesterification process requires expertise, appropriate equipment, and adherence to safety measures to ensure proper handling and conversion of waste cooking oil into biodiesel (Onukwuli et al., 2017).



**Figure 1:** Methanol structure

Methanol is a colorless, volatile liquid alcohol with the chemical formula CH<sub>3</sub>OH (Figure 1). It is the simplest alcohol and is commonly referred to as wood alcohol or methyl alcohol. Methanol is produced through the catalytic reaction of carbon monoxide and hydrogen, or by the destructive distillation of wood. Methanol has a wide range of applications across various industries. Some common uses include methanol can be used as an alternative or additive to gasoline in internal combustion engines. It is also used in fuel cells. Methanol is a versatile building block for the synthesis of various chemicals, such as formaldehyde, acetic acid, and methyl tert-butyl ether (MTBE). It serves as a solvent in industrial processes, including paint production, printing inks, and pharmaceutical manufacturing. Methanol is used as an additive in engine coolants and windshield washer fluids to lower the freezing point. Methanol is highly toxic if ingested, inhaled, or absorbed through the skin. It is metabolized in the body into formaldehyde and formic acid, which can cause severe health effects and organ damage, including blindness and death. Proper safety measures should be followed when handling or

using methanol. Methanol can also be produced from renewable sources, such as biomass or carbon dioxide (CO<sub>2</sub>) captured from industrial emissions. This renewable methanol can help reduce greenhouse gas emissions and provide a sustainable alternative to fossil fuel-based methanol. Methanol is primarily produced on an industrial scale using natural gas as a feedstock. It can also be produced from coal or biomass through gasification or syngas processes. Methanol has been used as a fuel for transportation in certain regions. Methanol-powered vehicles were more common in the past, but their use has decreased due to various factors, including safety concerns and the availability of alternative fuels (Lee et al., 2022).



**Figure 2:** Potassium hydroxide structure

Potassium hydroxide (KOH) is an inorganic compound with the chemical formula KOH (Figure 2). Potassium hydroxide is a strong base that is highly reactive and corrosive. Potassium hydroxide is a white, odorless solid that readily absorbs moisture from the air, making it deliquescent. It is highly soluble in water, producing an alkaline solution. The dissolution of potassium hydroxide in water is an exothermic process, releasing heat. Potassium hydroxide has various applications in different industries, including in chemical manufacturing which serves as a versatile reagent and catalyst in the production of various chemicals, such as soaps, detergents, fertilizers, dyes, and pharmaceuticals. While in industrial cleaning, potassium hydroxide is used in cleaning and degreasing applications due to its strong alkaline properties. It is utilized in food processing for purposes such as pH adjustment, caramel production, and peeling fruits and vegetables. Potassium hydroxide is a common catalyst used in the transesterification process to convert vegetable oils or animal fats into biodiesel. Potassium hydroxide is a versatile compound with various industrial applications, particularly in chemical manufacturing and pH regulation. However, its strong base and corrosive properties require careful handling and adherence to safety protocols (Madung et al., 2022).

## 2. Problem Statement

As more and more scientific evidence accumulates, new sources of alternative fuels need to be developed with properties comparable to petroleum-based fuels. Therefore, this study focuses on alternative sources such as mixed fuel using palm biodiesel to solve the problems that occur. The use of palm biodiesel blends has not yet been fully studied and understood in testing on diesel engines (Mishra et al., 2020). In searching for information on social media platforms, the statement of the problem that can be identified for now is that diesel fuel is getting more and more expensive. The currently expensive oil prices are expected to remain constant due to the low global oil stocks for several years. This situation puts further upward pressure on global oil prices in the future. Since 2021, crude oil prices have already on an upward trend as demand is supported by the post-Covid-19 reopening (Mohamed et al., 2022).

Apart from that, the second problem faced globally now is diesel fuel is less. This is likely due to the increase in vehicles over time. It is also due to the difficulty of getting the diesel oil itself because this oil is in such a complicated place that is under the ocean or underground.

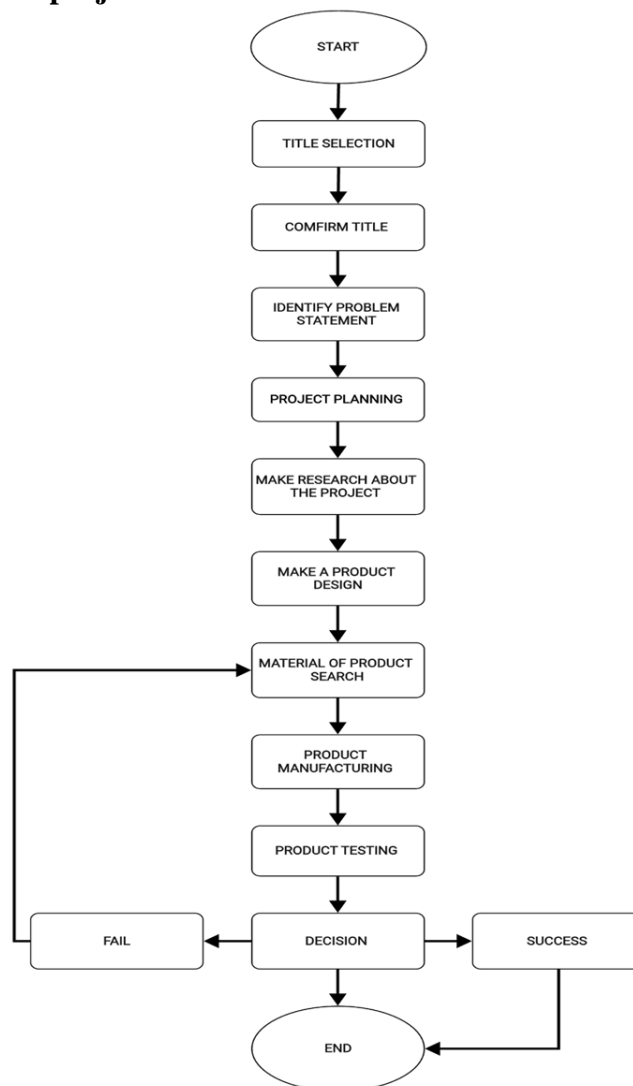
Next, the third statement faced by now is the increase in used cooking oil. We already know that cooking oil is an important ingredient for humans to prepare food. Because of that, used cooking oil is increasing day by day. This is a concern as this used cooking oil cannot be disposed of irresponsibly. Therefore, based on the problems facing the world now, our group has agreed to create a tool that can turn this used cooking oil into vehicle fuel more specifically called biodiesel fuel.

### 3. Methodology

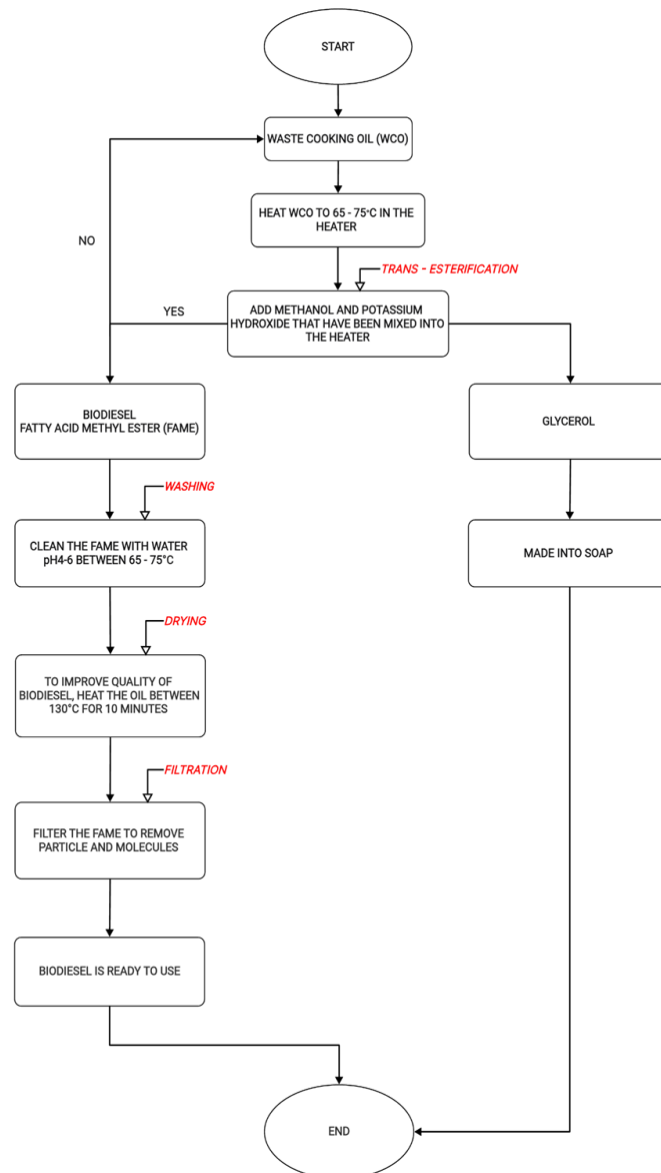
#### 3.1 Idea Generation and

The preceding work (Muhammad Haiqal Azmi et al., 2023) discussed the general process of ideation and Pugh Matrix-based ultimate design selection. Thus, the operation of the biodiesel processing reactor and its results were the main subjects of this article.

#### 3.2 Flowchart of the project



**Figure 3:** Flowchart of the project Biodiesel Processing Reactor



**Figure 4:** Flowchart of the transesterification process

### 3.3 Final Design

The design of a biodiesel reactor is a complex process that involves careful consideration of multiple variables to ensure efficiency, safety, and compliance with regulations. Key factors include selecting appropriate equipment, meeting specific process requirements, addressing scalability concerns, and prioritizing safety protocols. Engaging with engineering experts is indispensable during the development of a biodiesel reactor to leverage their specialized knowledge and experience. The choice of equipment for the reactor, such as pumps, heaters, and mixing systems, is critical in achieving optimal performance. Process requirements, including reaction conditions, catalyst selection, and feedstock characteristics, must be meticulously analyzed to design a reactor that meets production goals. Scalability considerations are essential to accommodate potential increases in production capacity, ensuring the reactor's adaptability to changing demands. Therefore, the previous paper (Muhammad Haiqal Azmi et al., 2023) has stated that safety concerns play a paramount role in biodiesel reactor design, necessitating the incorporation

of fail-safe mechanisms, emergency shutdown systems, and adherence to industry best practices. In summary, the design of a biodiesel reactor is a multifaceted process that demands expertise in engineering, process optimization, safety protocols, and regulatory compliance. Collaborating with professionals and staying informed about industry standards are essential steps in developing a biodiesel reactor that is not only efficient but also adheres to the highest safety and environmental standards.

#### 4. Results and Discussion

The biodiesel processing reactor, fundamentally a specialized apparatus in biodiesel production, stands as a renewable and eco-friendly alternative to conventional diesel fuel. Its pivotal role lies in the transesterification process, a chemical reaction transforming waste cooking oil, vegetable oils, animal fats, or other feedstocks into biodiesel. The reactor is characterized by its user-friendly design, portability, and environmentally conscious attributes, making it a noteworthy advancement in sustainable energy technology.

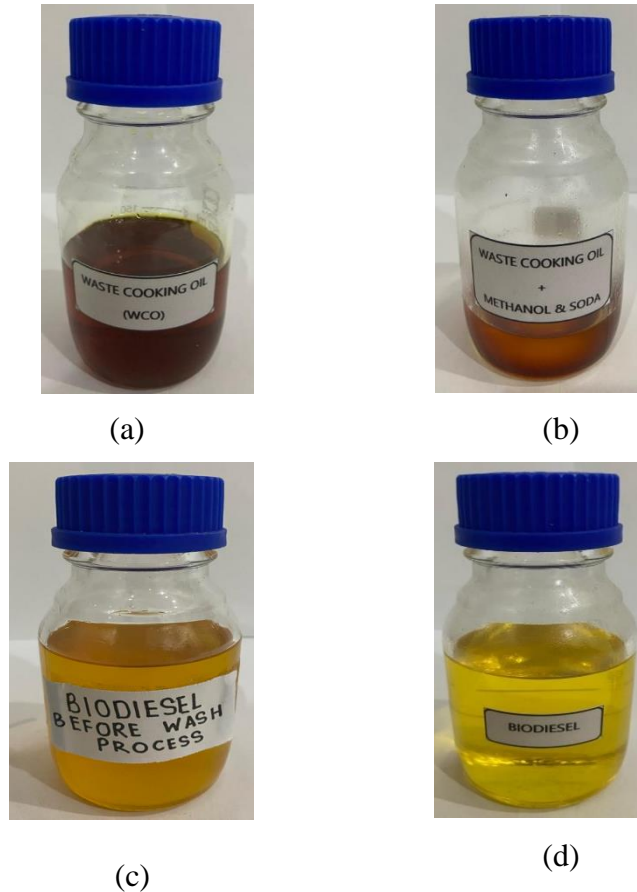
Moreover, the biodiesel processing reactor is strategically designed as a medium-sized item, ensuring convenience in storage without occupying excessive space. This attribute enhances its practicality and accessibility, aligning with the demand for efficient yet space-conscious equipment in biodiesel production facilities. The utilization of Inventor for creating the final design adds a layer of precision and efficiency to the project. The sketching process is meticulously aligned with established measurements, emphasizing accuracy and adherence to specifications. This phase is crucial in ensuring that the biodiesel processing reactor is not only conceptually sound but also practically feasible in terms of dimensions and structural integrity. In essence, the biodiesel processing reactor project, as outlined in this chapter, combines innovative design principles with a commitment to sustainability, culminating in a sophisticated yet practical solution for biodiesel production.

##### 4.1 Result of Biodiesel Processing Reactor



**Figure 5:** WCO Biodiesel Processing Reactor; (a) Front view, (b) Isometric view





**Figure 6:** Outcomes from the transesterification process; (a) Waste cooking oil (WCO), (b) Waste cooking oil + Methanol + Potassium hydroxide, (c) Biodiesel before the wash process, (d) Biodiesel completed.

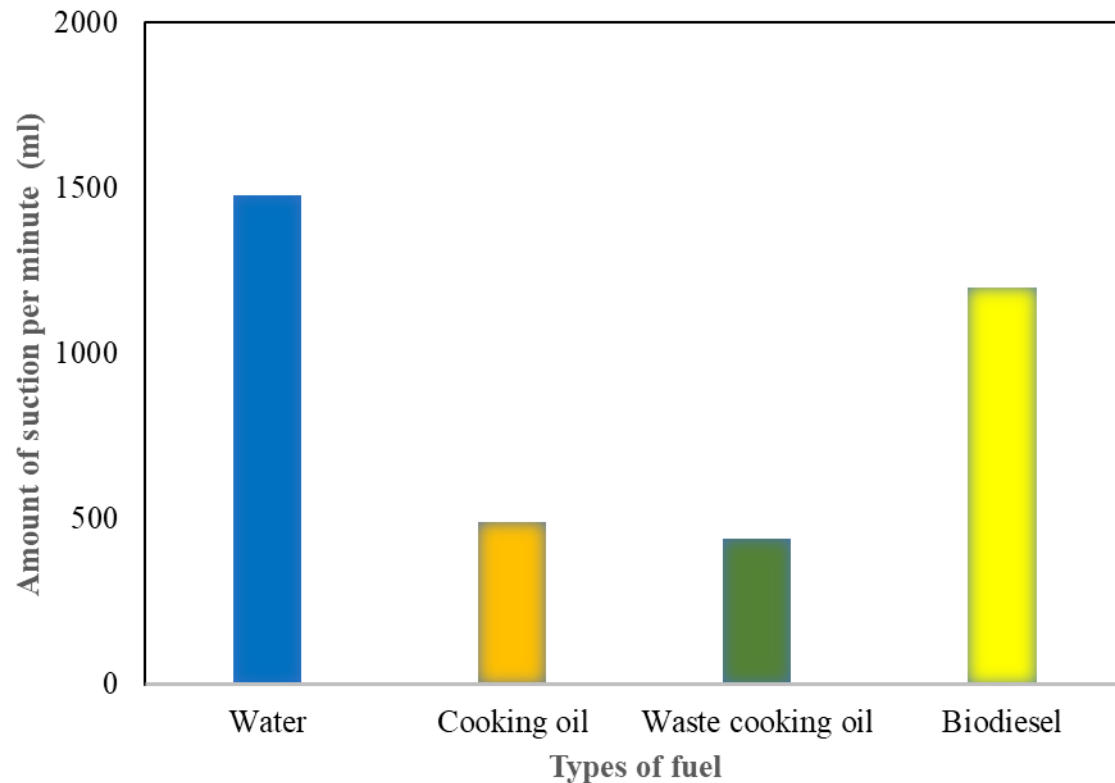
The completed construction of the biodiesel production reactor is depicted in Figure 5. The results of the transesterification of used cooking oil using the biodiesel processing reactor are displayed in Figure 6. The biodiesel processing reactor has allowed for a reduction in the length of this process.

#### 4.2 Functionality test for biodiesel processing reactor

The suction rate per minute (m/min) findings for a variety of fluids, such as water, cooking oil, waste cooking oil (WCO), and biodiesel, are listed in Table 1.

**Table 1:** Suction rate per minute (ml/min) for various fluids

Materials	Amount of suction per minute (ml/min)			Average (ml)
	Trial 1	Trial 2	Trial 3	
Water	1450	1490	1500	1480
Cooking oil	500	480	490	490
Waste cooking oil (WCO)	440	430	450	440
Biodiesel	1200	1190	1210	1200



**Figure 7:** The volume of suction per minute (ml/min) for various fluid types

Figure 7 shows the analysis of the amount of suction per minute in milliliters (ml/min) with different types of fluid. Firstly, differences in density, water is generally denser than most oils and biodiesel. The results show that water has the highest suction rate compared to other oil-based fluids. This is because of water viscosity, which is lower compared to other oil variations, as mentioned earlier, viscosity is a measure of a fluid's resistance to flow. If the pump is designed to handle lower-viscosity fluids more efficiently, it may be more effective at drawing in water. More than that, pump design and configuration, the design of the pump, including impeller type, size, and other factors, can influence its ability to handle different fluids. Some pumps may be more optimized for handling water than oils, or vice versa. Other than that, inlet conditions, the conditions at the inlet of the pump, such as the location and orientation of the intake, can affect what the pump draws in. If there are preferential flow paths for water, the pump may be biased towards pulling in more water. Finally, fluid properties, the specific properties of the fluids, including any additives or contaminants, can affect how they interact with the pump.

## 5. Conclusions

Overall, the WCO biodiesel processing reactor concept was quite interesting. Many unique concepts have been considered and added to this project throughout its development. Unfortunately, due to a lack of experience, resources, and time limits, some creative ideas must be rejected. All things considered, the project's objectives were satisfied with the chosen final design, which was selected after an idea creation process. As a result, just a select few are highlighted here:

- i. The problem of used cooking oil that can be chemically changed to be converted into valuable goods, like biodiesel, may be solved by this WCO biodiesel processing reactor.
- ii. Out of the three different suggested designs, the Pugh matrix was utilized to identify the best choice.
- iii. Water had the greatest suction rate, followed by cooking oil, waste cooking oil, biodiesel, and cooking oil.

## References

- Kezia Angeline, J., Kiruthika, G., Srivastav, S., Karthiga Prabha, K., & Joshua, V. (2020). Knowledge And Practice of Domestic Waste Disposal Management Among Female Residents in Ayapakkam, Tamil Nadu. *Indian Journal of Environmental Protection*, 40(2).
- Lee, A., Nandurkar, D., & Chandra, R. V. (2022). Methanol. In *Neuroimaging Pharmacopoeia, Second Edition*. [https://doi.org/10.1007/978-3-031-08774-5\\_3](https://doi.org/10.1007/978-3-031-08774-5_3)
- Madung, Z., Soloi, S., Majid, M. H. A., & Sarjadi, M. S. (2022). Production and characterization of Imperata cylindrica paper using potassium hydroxide as pulping agent. *Biodiversitas*, 23(3). <https://doi.org/10.13057/biodiv/d230337>
- Mishra, S., Chauhan, A., & Mishra, K. B. (2020). Role of binary and ternary blends of WCO biodiesel on emission reduction in diesel engine. *Fuel*, 262. <https://doi.org/10.1016/j.fuel.2019.116604>
- Mohamed, M., Sherif, N., Aboelazayem, O., Elazab, H. A., Gadalla, M., & Saha, B. (2022). Waste Cooking Oil Management in Egypt: Production of Biodiesel-Development of Rapid Test Method. *Journal of Physics: Conference Series*, 2305(1). <https://doi.org/10.1088/1742-6596/2305/1/012035>
- Muhammad Haiqal Azmi, Mohd Hafizil Mat Yasin, Muhammad Akmal Zikry Mohd Zamri, Muhammad Izzul Nizam Mohamad Nazri, & Muhammad Azrol Mohd Jaafar. (2023). A Preliminary Design of Portable Processing Reactor for Waste Cooking Oil (WCO) Biodiesel Production. *E-Proceedings the 5th Malaysia TVET on Research via Exposition 2023 (MaTRiX'23)*, 1–815.
- Onukwuli, D. O., Emembolu, L. N., Ude, C. N., Aliozo, S. O., & Menkiti, M. C. (2017). Optimization of biodiesel production from refined cotton seed oil and its characterization. *Egyptian Journal of Petroleum*, 26 (1). <https://doi.org/10.1016/j.ejpe.2016.02.001>
- Thushari, I., & Babel, S. (2022). Comparative study of the environmental impacts of used cooking oil valorization options in Thailand. *Journal of Environmental Management*, 310. <https://doi.org/10.1016/j.jenvman.2022.114810>

# Mobile RFID Attendance Recorder Based on Arduino

Hisyamsani bin Idris\*, Nik Izzul Farhan bin Nik Ghazali

Department of Electrical Engineering, Politeknik Sultan Mizan Zainal Abidin, 23000 Dungun Terengganu

\*Corresponding author E-mail: hisyamsaniidris@psmza.edu.my

## Abstract

The Mobile Attendance Recording Project based on Arduino is a system designed to automate the attendance recording process in educational institutions and workplaces while eliminating manual methods. By utilizing RFID technology, this system identifies and tracks the attendance of individuals, whether they are students or staff, along with additional information such as time and individual details. This project integrates the Node MCU8266 microcontroller, RFID reader, and a 16x2 LCD display. Users simply need to touch an RFID card or tag to confirm identity, and the attendance will be recorded and stored online via a Google Sheets application, automatically displayed on a mobile phone application. This enhances accessibility and provides an efficient solution for attendance management, reducing administrative burdens. The system is highly flexible and can be expanded to meet diverse needs.

**Key Words:** Attendance recorder, RFID technology, Arduino, Node MCU8266 microcontroller, automate attendance, Google sheet application.

## 1. Introduction

The RFID Attendance System project is a groundbreaking initiative set to transform conventional methods of monitoring attendance. By combining cutting-edge RFID technology with the capabilities of Arduino microcontrollers, this system offers a smooth and effective solution for automating attendance procedures across various industries, Aysha Qaiser and Shoab A Khan. (2006). Through the use of RFID readers for capturing and verifying user information, this project eliminates the manual workload associated with traditional attendance logging. M. K. Yeop Sabri et al (2007) stated that the gathered attendance data is intelligently stored in a database, ensuring easy access, efficient management, and seamless reporting. This innovative project is highly adaptable to different environments such as educational institutions, corporate setups, and healthcare facilities. It addresses the limitations of older attendance systems, presenting a forward-looking and cost-efficient alternative. The integration of RFID technology with Arduino reflects the project's dedication to ushering in a new era of precise, efficient, and convenient attendance monitoring.

Recognizing the inefficiencies and rigidity of manual attendance tracking methods, the study focused on harnessing RFID technology and NodeMCU microcontrollers to create an automated, cost-effective attendance recording system. The primary goal was to develop a user-friendly solution capable of accurately monitoring attendance in real-time without requiring complex installations. Claudio Talarico et al (2005); Grant Hornback et al (2001) and Wayne Wolf (2003) agreed that by leveraging RFID technology and Arduino boards, the project aimed to simplify attendance tracking, enhance accuracy, and boost efficiency. Insights gleaned from the research informed the creation of the RFID Attendance Recorder, offering a pragmatic solution to elevate attendance management practices.

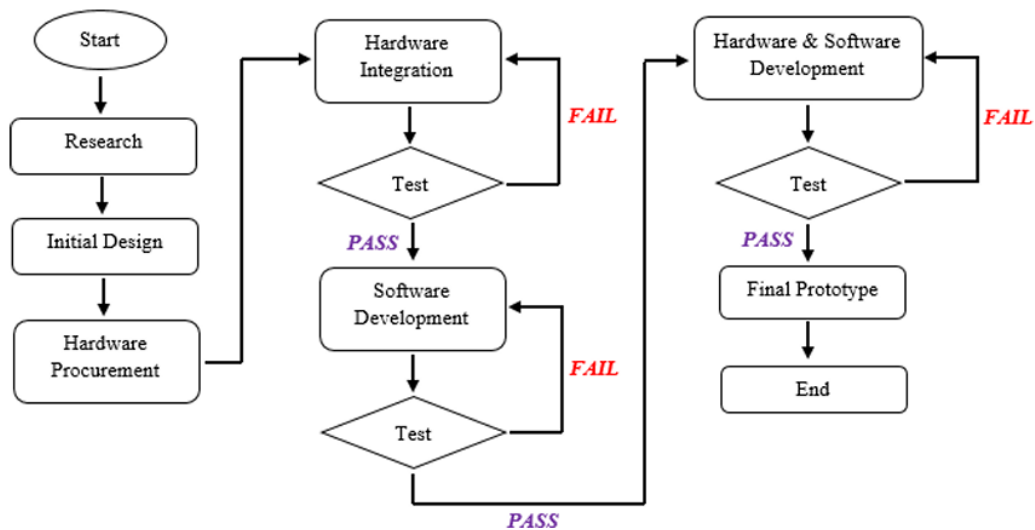
In response to the inefficiencies and inflexibility observed in manual attendance recording systems, the study aimed to address these issues by integrating RFID technology and Arduino

microcontrollers. The primary objective was to devise an automated and cost-efficient attendance recording system that simplifies the complexities inherent in conventional methods. The main focus was on creating a user-friendly solution capable of precisely monitoring attendance in real-time without requiring intricate setups. Through the utilization of RFID technology and Arduino boards, the project aimed to streamline the attendance tracking process, ensuring heightened accuracy and operational efficiency. Insights gleaned from the research informed the creation of the RFID Attendance Recorder, presenting a pragmatic and efficient solution to enhance attendance management.

## 2. Methodology

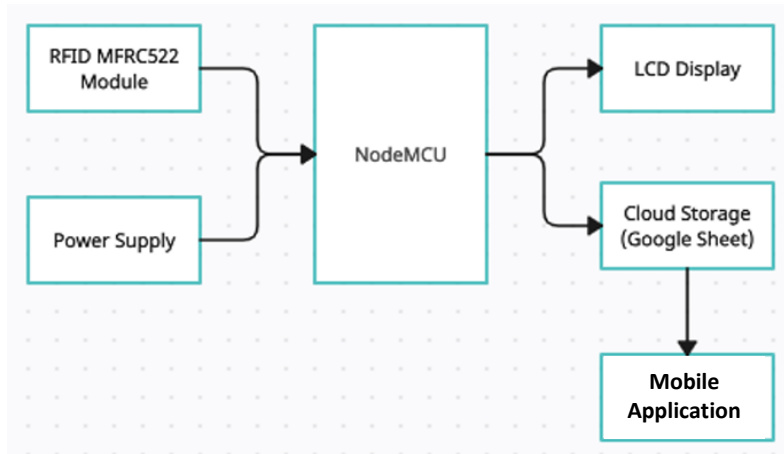
### 2.1 Design Methodology

For the successful realization of the RFID attendance recorder project, a detailed and organized plan is actively in motion. This plan involves a systematic progression through multiple stages including the collection of sample RFID tags, mechanical and circuit design, testing, and validation. Adhering to this thorough plan, the project aims to conclude within the set timeframe, ensuring a secure and operational product that fulfills its intended objectives.



**Figure 1:** Flow chart of Project flow methodology

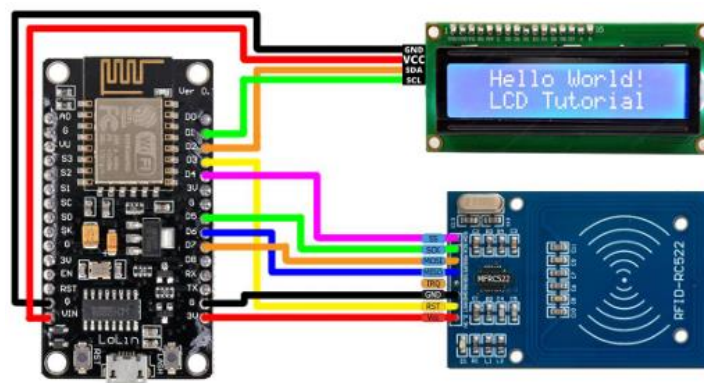
The system is set to employ RFID technology for swiftly and precisely capturing unique identification numbers from RFID tags, facilitating prompt and accurate recording of student attendance. Stored within a database, this recorded data allows for real-time monitoring and the generation of attendance reports. The project encompasses hardware design, integration with Arduino microcontrollers, and software development for effective data management and analysis. Through the creation of this RFID attendance recorder, the project seeks to enhance the efficiency of attendance tracking, minimize manual errors, and streamline processes in both educational and professional environments.



**Figure 2:** Block Diagram for Mobile RFID Attendance recorder

## 2.2 Hardware Implementation

The schematic layout of the project strategically establishes connections among the MFRC522 RFID module, NodeMCU microcontroller, and the 16x2 LCD with I2C module to enable seamless communication and integration. The MFRC522 RFID module, responsible for reading data from RFID cards, interfaces with the NodeMCU board through specific pins, ensuring reliable data exchange. Acting as the system's core, the NodeMCU processes the RFID data and orchestrates the overall operation. Moreover, the 16x2 LCD with I2C module communicates with the NodeMCU via the I2C protocol, simplifying connections and reducing wiring complexities. This efficient setup guarantees that the RFID data processed by the NodeMCU is displayed on the LCD interface, offering a user-friendly experience for real-time attendance monitoring. The deliberate arrangement of these components in the schematic demonstrates a meticulous design focused on optimizing functionality and enhancing user convenience.

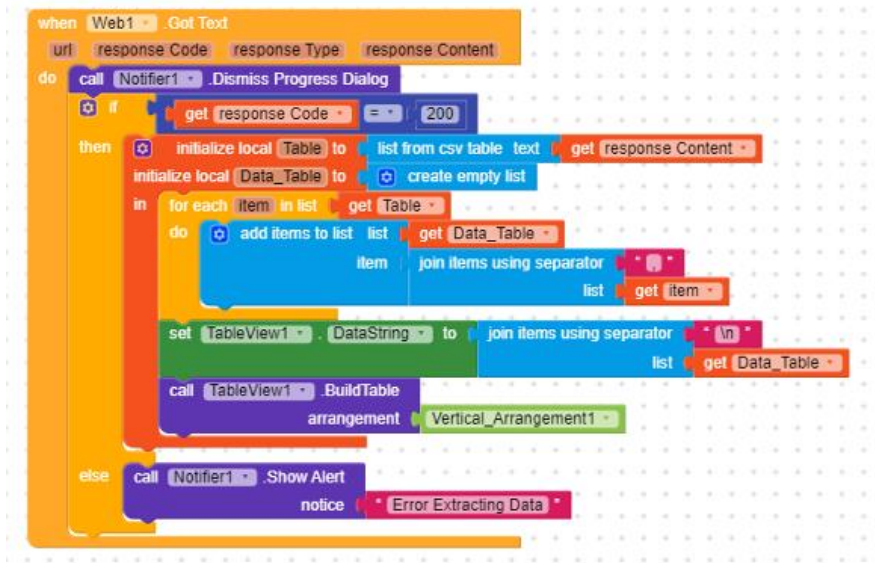


**Figure 3:** Schematic Diagram

## 2.3 Software Implementation

Within the RFID attendance recorder project, Kodular plays a crucial role in crafting and constructing the mobile application interface. Kodular operates within a visual programming environment, utilizing a drag-and-drop methodology that empowers the creation of Android applications without necessitating extensive coding expertise. This platform equips developers with the tools to fashion an intuitive and user-friendly mobile

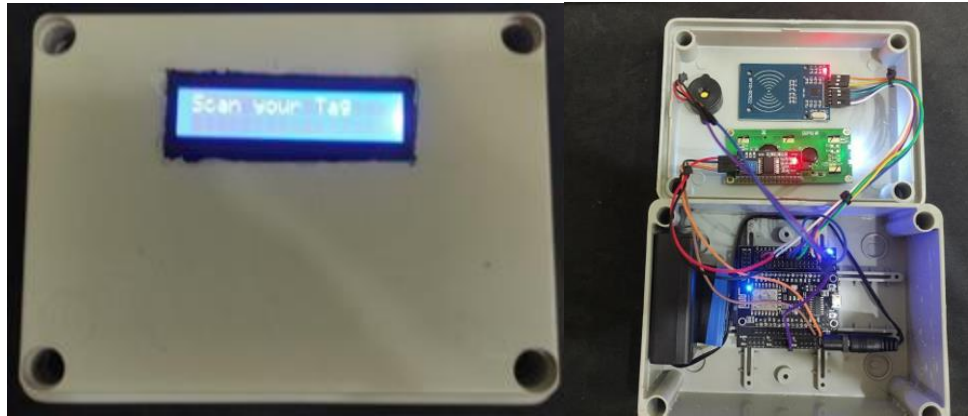
interface customized to suit the precise needs of the RFID attendance system. Offering an array of components and blocks, Kodular simplifies the integration of functionalities such as QR code scanning, real-time data visualization, and interaction with the NodeMCU ESP8266 board. Leveraging Kodular's graphical interface, developers seamlessly link the mobile application with hardware elements, fostering seamless communication between users' mobile devices and the RFID attendance system. Kodular's adaptability extends to implementing features like user authentication, attendance monitoring, and synchronization with Google Sheets. Overall, Kodular streamlines the mobile application's development, enhancing accessibility and usability for end-users.



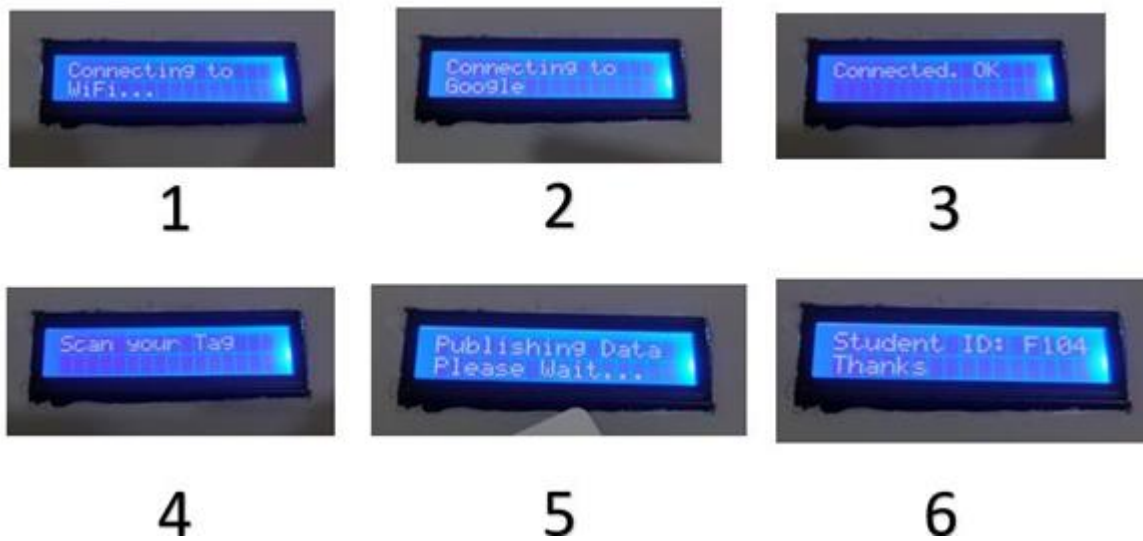
**Figure 4:** Visual Programming for mobile application using Kodular

### 3. Results and Analysis

The outcomes of this project highlight the successful deployment of an RFID Attendance Recorder utilizing the NodeMCU ESP8266 platform. Rigorous testing affirmed the system's consistent capability to capture and promptly transmit attendance data to Google Sheets in real-time. The user-friendly LCD display effectively presented student information, significantly enhancing the system's usability. Challenges concerning network connectivity and RFID tag readability were effectively addressed, contributing to the overall reliability of this solution. Performance optimization ensured the system's efficiency and accuracy in attendance monitoring. While the project achieved its primary objectives, ongoing refinement and bug resolution remain critical for sustaining its long-term effectiveness. The RFID Attendance Recorder stands as an economical and effective solution, offering a promising alternative to conventional attendance tracking methodologies in both educational and professional environments.



**Figure 5:** Hardware external and internal look

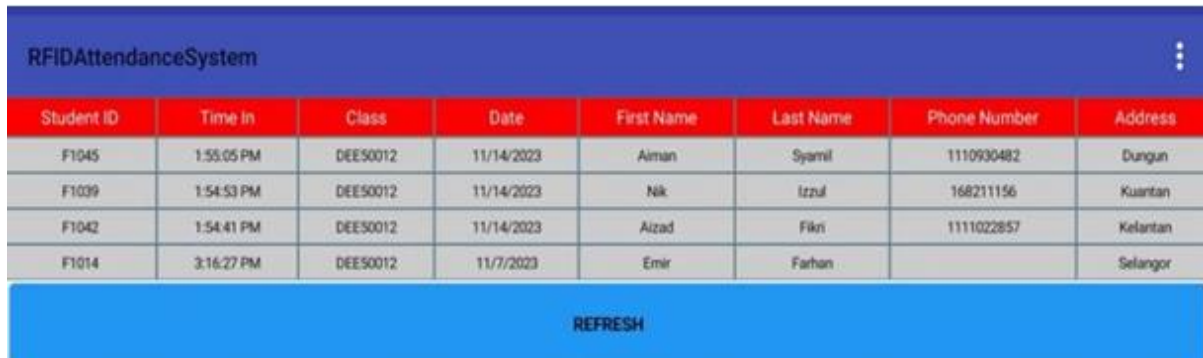


**Figure 6:** LCD Display Output

A	B	C	D	E	F	G	H
Student ID	Time In	Class	Date	First Name	Last Name	Phone Number	Address
F1042	5:43:31 PM	DEE50012	11/18/2023	Aizad	Fikri	1111022857	Kelantan
F1045	5:43:16 PM	DEE50012	11/18/2023	Aiman	Syamil	1110930482	Dungun
F1039	1:54:53 PM	DEE50012	11/14/2023	Nik	Izzul	168211156	Kuantan
F1042	1:54:41 PM	DEE50012	11/14/2023	Aizad	Fikri	1111022857	Kelantan
F1014	3:16:27 PM	DEE50012	11/7/2023	Emir	Farhan		Selangor

**Figure 7:** Screen shot view of output from Google Sheet application.





Student ID	Time In	Class	Date	First Name	Last Name	Phone Number	Address
F1045	1:55:05 PM	DEE50012	11/14/2023	Alman	Syamil	1110930482	Dungun
F1039	1:54:53 PM	DEE50012	11/14/2023	Nik	Izzul	168211156	Kuantan
F1042	1:54:41 PM	DEE50012	11/14/2023	Aizad	Fikri	1111022857	Kelantan
F1014	3:16:27 PM	DEE50012	11/7/2023	Emir	Farhan		Selangor

REFRESH

**Figure 8:** Screen shot view of output from Android Application in smart phone

An in-depth analysis of the RFID Attendance Recorder project unveils significant insights into its operational efficiency and performance. Extensive testing has confirmed the system's reliability in promptly capturing and transmitting attendance data, underscoring its real-time functionality. The user interface, integrated via an LCD display, underwent evaluation to gauge its clarity and efficacy in presenting student information. Testing challenges, including network connectivity and RFID tag readability issues, were meticulously scrutinized, pinpointing areas ripe for enhancement. System code underwent optimization to bolster efficiency and ensure precise data tracking. The project's success lies in its ability to tackle conventional attendance tracking hurdles, offering a streamlined and cost-efficient resolution. Continuous analysis and refinement are pivotal for upholding the system's efficacy and addressing emerging concerns. Overall, the RFID Attendance Recorder project stands as a valuable contribution, presenting a dependable and efficient alternative for attendance management across diverse educational and professional environments.

#### 4. Summary and Recommendations

In summary, the RFID Attendance Recorder project effectively overcomes the limitations of traditional tracking systems by introducing an affordable, efficient, and eco-friendly solution. By integrating NodeMCU ESP8266 and RFID technology, it creates an automated, real-time attendance system. Google Sheets integration streamlines data management for seamless tracking and reporting. The development involved creating a user-friendly LCD interface, robust data handling code, and rigorous testing for reliability. Addressing challenges led to an optimized end product, showcasing IoT device potential in educational and professional settings. Its green technology, including reduced paper usage and energy efficiency, aligns with sustainability goals. As a scalable and cost-effective option, this Recorder holds promise for widespread adoption, enhancing attendance efficiency across sectors. This success underscores the importance of technology in refining traditional processes for more accurate, sustainable, and streamlined practices.

In enhancing the RFID Attendance Recorder project, two key recommendations emerge. Firstly, developing a dedicated mobile application would offer users and administrators a streamlined interface for real-time attendance management. This app could incorporate features such as push notifications and remote data access, enhancing user convenience. Additionally, integrating advanced analytics driven by machine learning algorithms within the app would provide institutions with predictive attendance insights, supporting data-driven decisions.

Furthermore, to align with global sustainability initiatives, exploring alternative power sources like solar panels for the system aligns with green technology efforts. These improvements, alongside ongoing stakeholder collaboration and customizable user interface options, ensure the project's adaptability across diverse settings. These recommendations aim to strengthen the RFID Attendance Recorder as a user-friendly, efficient, and sustainable attendance tracking solution, bolstered by a dedicated mobile app.

## References

- Aysha Qaiser and Shoab A Khan. (2006). *Automation of Time and Attendance Using RFID System*. IEE-ICET 2nd International Conference on Imaging Technology
- Claudio Talarico, Aseem Gupta, Ebenezer Peter, Jerzy W. Rozenblit (2005). *Embedded System Engineering Using C/C++ Based Design Methodologies*, 12th IEEE International Conference And Workshop on The Engineering of Computer-Base System
- Grant Hornback, Alex Babu, Bobby Martin, Ben Zoghi, Madhav Pappu, and Rohit Singhal (2001). *Automatic Attendance System Journal*, from RFIDSensNet Lab
- M. K. Yeop Sabri, M. Z. A. Abdul Aziz, M. S. R. Mohd Shah, M. F. Abd Kadir (2007). *Smart Attendance System By Using RFID*. Asia Pacific Conference on Applied Electromagnetics Proceedings
- Wayne Wolf (2003). *'A Decade of Hardware/ Software Co-design*. IEEE 5th International Symposium Multimedia Software Engineering (MSE)

## Mini EV Car

**Muhd Hasanul Isyraf Bin Mat Junoh<sup>1\*</sup>, Ahmad Kharun Syazwan Bin Mat Khari<sup>2</sup>,  
Muhammad Farieddin Bin Anuar<sup>2</sup>, Muhammad Akmal Danial Bin Nasrudin<sup>2</sup>,  
Muhammad Fakhrol Hadi Bin Hamidi<sup>2</sup>**

<sup>1</sup>Automotive Technology Centre (ATeC), <sup>2</sup>Department of Mechanical Engineering, Politeknik Sultan Mizan  
Zainal Abidin, 23000 Dungun Terengganu

\*Corresponding author E-mail: hasanul.isyraf@psmza.edu.my

### Abstract

Malaysia is a country heading towards a developed country however most cars in this country use internal combustion engines. Nowadays, the old method of using petrol as fuel is still used. This old method causes carbon emissions. For this reason, this project is a promising technology to achieve sustainable transport, due to very low to zero carbon emissions, low noise and high efficiency. The Mini EV Car is an electric vehicle with a green mobility concept that is environmentally friendly by applying green technology that does not use gasoline and at the same time will reduce environmental pollution. The Mini EV Car was designed buggy-shaped by using Autodesk Inventor and the chassis is made from hollow mild steel using the mig welding method. It was driven by a 1000W Brushless Direct Current Motor (BLDC) and a 48V lead acid rechargeable battery. From the performance test, Mini EV Car can reach a maximum speed of 30 km per hour and battery can support maximum distance at 37 km without outsource charging with two people on the car. This Mini EV Car is very suitable for driving at close distances such as in housing estates, urban vehicles, in agricultural fields nor as a tourist vehicle in tourist places.

*Key Words: Electric vehicle, battery, charging, emission, brushless direct current motor*

### 1. Introduction

Electric vehicle technology Electric vehicle technology has grown rapidly since its introduction and there are now many options of electric vehicles, either hybrid or fully battery available on the market. Conventional vehicles with internal combustion engine technology are driven by combustion generated by fuel such as gasoline or diesel. This technology is very reliable, but it uses a large amount of expensive gasoline. Electric vehicles do not use fuel to power them.

Electric vehicles are driven by electromagnetism which is used in all electric vehicles. The use of these EVs is growing because they are more efficient. It is also the most energy efficient and produces zero tailpipe emissions.

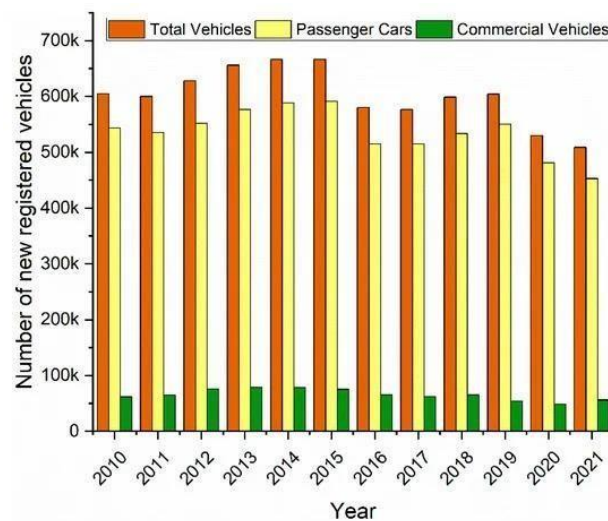
EV is one of the green technologies developed in an effort to reduce greenhouse gases produced by air pollution and gases that can cause climate change (Veza *et al.*, 2022). Electric vehicles (EV) are products in development that are expected to contribute to reducing pollution that can effectively maintain clean air on the road, directly improving air quality (Casal *et al.*, 2016).

EV technology has been established in the global market, as demonstrated by the availability of commercial EVs. In the supply chain, although the number of EVs in the global market has increased drastically, the mass production of batteries and electric motors remains the biggest problem. EV battery manufacturers are relatively small compared to the high demand for EV products. Therefore, the battery is still the most expensive component in an EV. On average, batteries make up about 40% of the total cost of EV manufacturing

(König *et al.*, 2021). One concern of EVs is the issue of safety and disposal of batteries at the end of their useful life.

The Malaysian automotive industry is driven by several government agencies under different ministries. The Malaysian Automotive IoT and Robotics Institute (MARii) is an agency established under the jurisdiction of the Malaysian Ministry of International Trade and Industry (MITI) which functions as a coordinating center and think tank towards improving the automotive industry and overall mobility in Malaysia. In collaboration with MARii, MITI released the latest National Automotive Policy 2020 (NAP 2020). Among other things, NAP 2020 highlights the development of Next Generation Vehicles (NxGV) in the fields of charging, energy management and safety. The directions include a focus on Next Generation Vehicles (NxGVs), Mobility as a Service (MaaS) and Industry 4.0, and the plan will incorporate the development of Automated, Autonomous, Connected Vehicles (AACV), lightweight material technology as well as hybrid, electric and fuel cell vehicles.

As one of the fastest developing nations in Southeast Asia, Malaysia has a population of 32.7 million in the first quarter of 2021 and is expected to reach 41.5 million by 2040. Statistics from ASEAN Statistics Division for 2020 revealed that Malaysia had 29.96 million registered motor vehicles in 2019. In the same year, Malaysia recorded 925 registered motor vehicles per 1000 population which depicts that nine out of every ten Malaysians have a road vehicle. With no restrictions on vehicle ownership, roads in Malaysia are being dominated by passenger vehicles (46.0%) and motorcycles (48.4%) according to (Kondo, 2018), as can be seen in Figure 1.



**Figure 1:** New passenger and commercial vehicles registered in Malaysia (MAA, 2021)

## 2. Problem Statement

The problem faced at the global level is the increase in the number of internal combustion engine vehicles affecting the environment in terms of air pollution due to the emission of vehicle smoke. The increase in the price of petrol and diesel fuel also puts a financial burden on consumers for the cost of fuel for internal combustion engine vehicles and further increases the cost of living for consumers. Solutions need to be done to overcome this problem at an early stage through the study and development of environmentally friendly and affordable electric vehicles.

## **2.1 Objective**

The objectives of this project are:

- i. To design mini car
- ii. To design mini car
- iii. To develop mini cars with electric power
- iv. To analyze performance of electric cars and endurance of battery

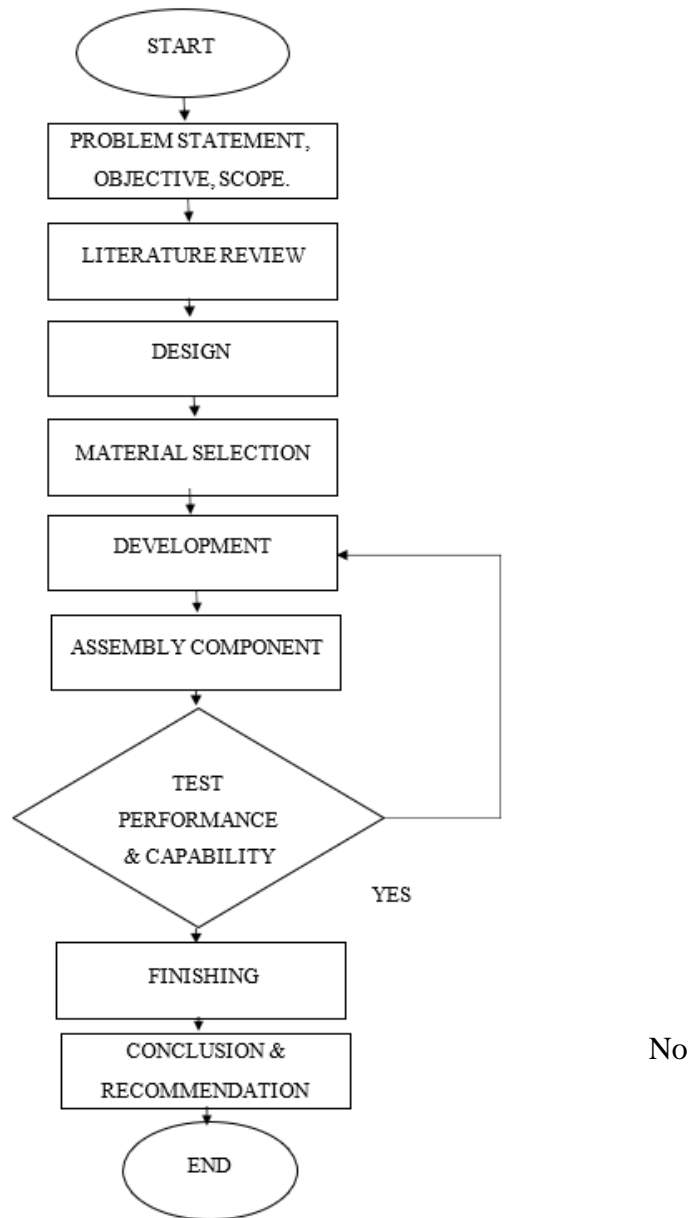
## **2.2 Scope**

The scope of these projects is:

1. This vehicle has two seats that can accommodate a load of up to 200kg.
2. A 48v battery lead-acid is used, which is a combination of four 12V type batteries that can be rechargeable.
3. The chassis is made of mild steel rectangular hollow section that be able to withstand the load.
4. The car can be moved with the entire load including passengers using 1000W Brushless Direct Current motor (BLDC).
5. This car is also equipped with reverse gear.
6. The dimensions of the car are 6 ft of length and 4 ft of width.

## **3. Material and Method**

In producing a project, several steps need to be taken before the project is completed. These steps need to be taken carefully in order to produce a quality project. In producing this project, there are several steps that have been done by following the flow chart as shown as in Figure 2 below.



**Figure 2:** Flow chart Mini EV Car Project

### 3.1 Morphology Chart

The morphology chart as shown in table 1 is used to generate a conceptual design for the Mini EV car. The best combination of three ideas will be used to develop three concept designs.

**Table 1:** Morphology Chart

BIL	NAME	IDEA 1	IDEA 2	IDEA 3
1	BATTERY	 Li-Ion Battery	 Lead-Acid Battery	 Wet Battery
2	AXLE	 CV joint Axle	 Chain and Sprocket	 Rear Differential Axle
3	WHEEL	 ATV Wheel	 Motorcycle Wheel	 Car Wheel
4	MOTOR	 AC Motor	 Brushed DC	 Brushless DC
5	METAL	 ALUMINIUM	 MILD STEEL	 TAINLESS STEEL
6	FRONT SUSPENSION	 Leaf Spring	 MACPHERSON STRUT	 DOUBLE WISHBONE
7	REAR SUSPENSION	 Leaf Spring	 Torsion Beam	 Multi-Link
8	SEAT	 Bucket Seat	 Fabric Seat	 Leather Seat

### 3.2 Design Selection

Design selection is a process to get the variations of design and will choose what design is good to be constructing. The idea of selecting the design is shown in the drawings. This is to conclude the research information and decomposition characteristics that need to exist in the design.

#### 3.2.1 First Conceptual Design

For design A as seen in figure 3, this design use a shock as absorber for front and rear suspension and it us CV joint drive shaft that connects to a sprocket to replace the axle to move it. It will use chain sprocket to move from dc motor, this concept is similar to the use of bicycles and motorcycles.

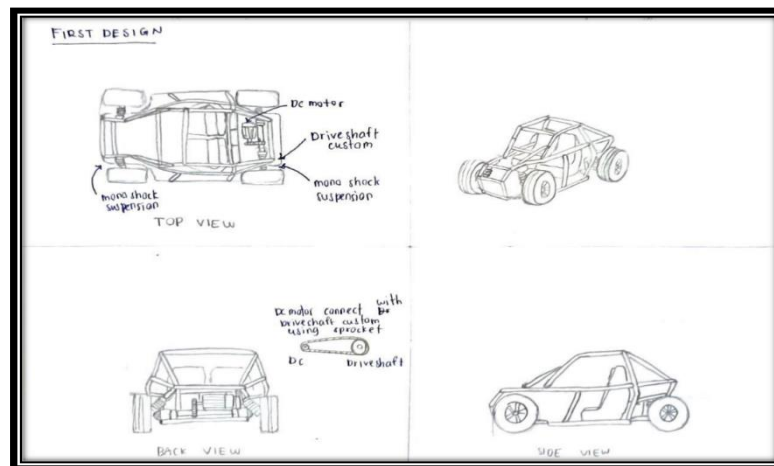


Figure 3: Design A

#### 3.2.2 Second Conceptual Design

For design B as seen in figure 4, it uses suspension double wishbone for r front and leaf spring solid axle to move it exactly like a car use Rear wheel drive (RWD) system.

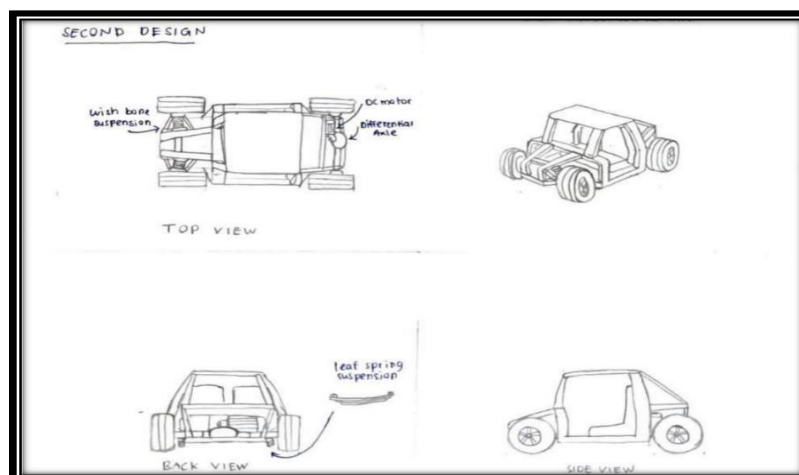


Figure 4: Design B



### 3.2.3 Third Conceptual Design

For design C as seen in figure 5, it uses a sprocket directly for replace the axle to move it. It will use chain sprocket to move from dc motor, this concept is similar to the use of bicycles and motorcycles but suspension is same with design A.

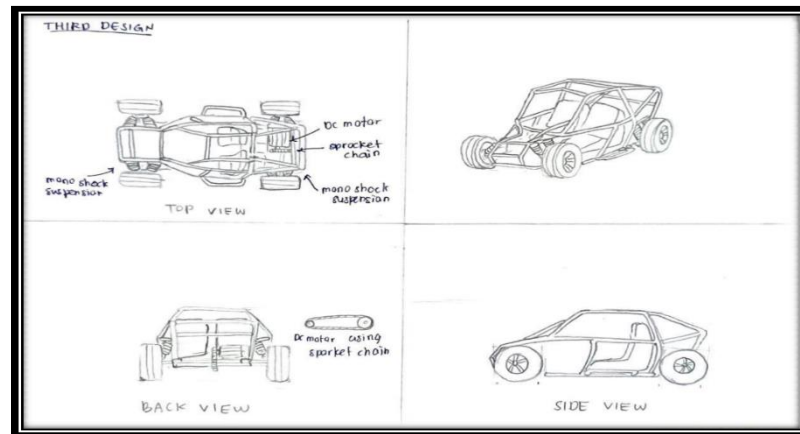


Figure 5: Design C

### 3.3 Concept Screening

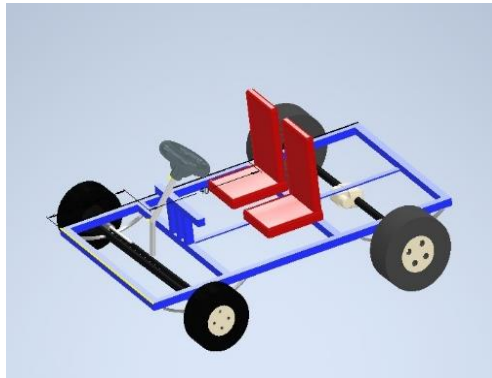
Table 2 below shows concept screening of conceptual design for design A, design B and design C based on criteria and the value plus, same or minus compared with reference. From the result design B is the best design and it used to develop Mini EV Car.

Table 2: Concept Screening

Selection Criteria	Concept			
	Design A	Design B	Design C	REF
Easy to manufacture	-	-	-	0
Cost	-	-	-	0
Practicality	-	+	-	0
Easy to Move	+	+	+	0
Tool Storage	-	+	-	0
Comfort	+	+	+	0
Safety	-	+	-	0
Maintenance	+	+	-	0
Plus	3	6	2	0
Same	4	4	4	0
Minus	5	3	6	0
Net Score	-2	3	-4	0
Rank	2	1	3	0
Continue?	Yes	Yes	No	

### 3.4 Final Design

Based on the selection conceptual design, final design is developed by using Autodesk Inventor software. Figure 6 below shown final design of Mini EV Car.



**Figure 6:** Design of Mini EV Car

### 3.5 Fabrication Process

The following is the fabrication process to produce a mini EV car until it is ready to be developed.

1. Measure the height between the axle and the chassis iron before welding
2. Cut square hollow iron according to the size of the drawing
3. Welding it use corner joint method
4. Assemble the leaf spring and axle to the chassis
5. Apply the steering rack to tire
6. Then measure the size of the battery for the located it to the back
7. Complete the chassis with metal sheet
8. Install the seat on the frame chassis
9. Wiring controller, battery and electronic component
10. Painting the chassis
11. Testing on chassis load, speed performance and battery durability.



**Figure 7:** Mini EV-Car

## 4.0 Result and discussion

### 4.1 Speed Performance

Table 3 shows the result of speed test performance. The maximum speed of Mini EV Car is able to achieve 30km/h meanwhile the average speed is 12 km/h. It shows that the Mini EV Car is suitable for short distance driving as for recreation purposes.

**Table 3:** Speed performance of Mini EV Car

Maximum speed	Average speed
30 km/h	12 km/h

#### 4.2 Analysis of Endurance Battery and Distance

Mini EV Car used 4 units of 12 V a Lead-Acid type battery and wired in serial circuit so that its equivalent to 48V of power supply. Referring to Table 4 below, this electric car was tested when the battery is full voltage. The battery on the electric car reaches a distance of 37 km. While a battery of 70% reaches a distance of 20 km and battery at 20% reaches a distance of 5km.

In addition, load also plays an important role in battery life. The higher the load carried; the more energy is used from the battery power supply. But with the use of brushless direct current motor (BLDC) electricity will always be generated because it acts as a generator. Maximum speed on this electric car reaches up to 30km/h with a load weight of 160kg for two passengers. If the battery runs out, this electric car can also recharge the battery. Charging only takes an hour for the battery to be fully charged.

**Table 4:** Battery Usage Vs Distance Traveled

Battery Percentage	Distance Traveled (km)
20%	5
70%	20
100%	37

#### 5. Conclusion

Finally, the Mini EV Car was successfully designed and fabricated as it is. The results of the tests and analysis conducted found that the Mini EV Car can reach a maximum speed of 30km/h and the battery can last as far as 37km of travel. This Mini EV car can be further improved in its development to be more efficient and equipped with the necessary accessories for a car. Cars like this can help users save on gasoline costs and save the environment.

## References

- Casals, L.C.; Martinez-Laserna, E.; García, B.A.; Nieto, N. (2016). Sustainability analysis of the electric vehicle use in Europe for CO2 emissions reduction. *J. Clean. Prod.*, 127, 425–437.
- Kondo, H. (2018). *Sustainable Development of the Transport Sector: Malaysia*; Economic Research Institute for ASEAN and East Asia: Jakarta, Indonesia.
- König, A.; Nicoletti, L.; Schröder, D.; Wolff, S.; Waclaw, A.; Lienkamp, M. (2021). An overview of parameters and costs for battery electric vehicles. *World Electr. Veh. J.* 2021,12, 21.
- Malaysian Automotive Association. Ministry of International Trade and Industry. National Automotive Policy 2020. (2020). Available online: [https://www.miti.gov.my/miti/resources/NAP2020/NAP2020\\_Booklet.pdf](https://www.miti.gov.my/miti/resources/NAP2020/NAP2020_Booklet.pdf) (accessed on 8 September 2021).
- Malaysian Automotive Association. Sales & Production Statistics. Available online: <http://www.maa.org.my/statistics.html> (accessed on 8 September 2021).
- Veza, I., Abas, M. A., Djamari, D. W., Tamaldin, N., Endrasari, F., Budiman, B. A., Idris, M., Opia, A. C., Juangsa, F. B., & Aziz, M. (2022). Electric Vehicles in Malaysia and Indonesia: Opportunities and Challenges. *Energies*, 15(7). <https://doi.org/10.3390/en15072564>

## Stargazer The Sound Insulation (SSI) For Los Angeles Resistance Abrasion (LA) Machine

Nor Suriani Binti Mohd Nor\*, Nur Hidayatul Fatimah Bt Nor Mohairi, Nurmayuni Bt Kamurulzaman,  
Nur Azira Ruwaidah Bt Rosli, Nur Azrin Syafarina Bt Mohd Azlan

Department of Civil Engineering, Politeknik Sultan Mizan Zainal Abidin, 23000 Dungun Terengganu

\*Corresponding author E-mail: nor.suriani@psmza.edu.my

### Abstrak

Tujuan projek ini dijalankan adalah untuk menghasilkan alat penebat bunyi untuk menyelesaikan masalah bunyi bising pada mesin *Los Angeles Resistance Abrasion* yang terdapat di Bengkel Jalan Raya, Jabatan Kejuruteraan Awam (JKA), Politeknik Sultan Mizan Zainal Abidin. Alat ini dapat membantu menyelesaikan masalah bunyi bising yang dikeluarkan oleh mesin tersebut semasa ia beroperasi. Mesin ini boleh mendatangkan kerosakan kepada pendengaran telinga warga PSMZA yang berada berhampiran Bengkel Jalan Raya tersebut. Malah mesin tersebut juga boleh menyebabkan aktiviti di persekitaran bengkel terganggu contohnya aktiviti Pengajaran dan pembelajaran (PdP) serta aktiviti lain. Melalui penghasilan produk ini, ia mampu mengurangkan bunyi yang dihasilkan oleh mesin *Los Angeles Resistance Abrasion*. Alat ini dinamakan *Stargazer Sound Insulation* atau pun *SSI*. Ianya memainkan peranan yang penting bagi mengurangkan masalah bunyi bising di sekitar Bengkel Jalan Raya, JKA. Terdapat dua objektif dalam kajian produk ini iaitu bagi menghasilkan alat penebat bunyi pada mesin *Los Angeles Resistance Abrasion* dan menguji keberkesanan produk yang dihasilkan dengan mengukur kekuatan bunyi mesin selepas produk dihasilkan menggunakan aplikasi *Sound Meter*. Kajian produk berbentuk kajian inovasi dimana alat dihasilkan untuk mengurangkan kadar kebisingan yang melampau yang dikeluarkan semasa mengoperasikan *Los Angeles Resistance Abrasion Machine*. Dengan penghasilan produk ini ia mampu mengurangkan bunyi bising dengan mengukur kadar pengurangan kekuatan bunyi melalui aplikasi *Sound Meter*. Disamping itu, keistimewaan penghasilan produk ini juga ialah banyak menggunakan bahan-bahan terpakai seperti bekas telur, span, kain fabrik terpakai dan lain-lain lagi. Pengumpulan data di buat dengan menjalankan ujian menggunakan aplikasi *sound meter* untuk mengenal pasti tahap kekuatan bunyi yang berlaku. Seterusnya hasil ujian tersebut dibandingkan dengan spesifikasi yang ditetapkan oleh Standard World Health Organization (WHO) untuk menentukan keberkesanan produk. Secara keseluruhannya, produk *Stargazer Sound Insulation (SSI)* ini berfungsi dengan baik di mana hasil dapatan yang diperolehi mampu mengurangkan kadar bunyi yang dikeluarkan oleh *Los Angeles Resistance Abrasion Machine*. Justeru itu wajarlah kiranya kajian produk yang dinamakan *Stargazer Sound Insulation (SSI)* ini terhasil kerana ia mampu mengurangkan bunyi bising malah mengurangkan pencemaran bunyi.

**Kata Kunci:** *Stargazer Sound Insulation (SSI) Los Angeles Resistance Abrasion Machine, pencemaran bunyi, kekuatan bunyi, aplikasi Sound Meter, Fabrik. WHO.*

### 1. Pengenalan

Pencemaran bunyi bukanlah sesuatu yang baru di Malaysia. Namun, masih ramai lagi yang tidak peka dan tidak tahu bahawa pencemaran bunyi juga merupakan salah satu daripada pencemaran alam sekitar yang berbahaya selain dari pencemaran udara dan pencemaran air. Pencemaran bunyi ini kurang dipandang serius kerana ianya sukar untuk dikesan dengan mata kasar. Walaupun pencemaran bunyi tidak dapat dilihat, namun pencemaran ini tetap ada di sesetengah kawasan seperti di kawasan kilang, kawasan tapak pembinaan dan kawasan lebuh raya.

Menurut Adib Danial (2021), bunyi bising yang melebihi 85 dBA selama lapan jam secara berterusan, ia mungkin akan menyebabkan kerosakan terhadap gegendang telinga dan dikhuatiri akan mengakibatkan pekak. Pencemaran dan gangguan bunyi juga boleh menyebabkan stress dan tekanan emosi tanpa boleh berfikir atau melakukan kerja dengan tenang. Hal ini akan memberi kesan kepada individu tanpa mengira umur sama ada kanak-kanak mahupun dewasa.

Merujuk kepada Akta Kualiti Alam Sekeliling 1974, di bawah Seksyen 23, individu yang didapati tidak berlesen yang menyebabkan atau mengeluarkan bunyi bising yang lebih kuat bahana, akan dikenakan denda tidak lebih daripada RM100,000 atau penjara selama tempoh tidak lebih dari lima tahun atau kedua-duanya sekali dan denda tambahan tidak lebih dari RM500 sehari bagi setiap hari kesalahan itu diteruskan selepas diberikan notis oleh Ketua Pengarah supaya berhenti melakukan perbuatan yang menyebabkan bunyi bising itu berlaku.

*"Noise Pollution and Control Strategy discusses the basics of acoustic propagation, reviews the problem of noise generation over all national and international situations and gives various techniques available for noise measurements and assessment, health effects of noise, the standards adopted by various countries of the world, environmental impact assessment techniques, control measures and status of noise measurement and abatement practices. In the last chapter, an effort has been made to lay an appropriate strategy to control noise."*

*S P Singal (2005), Noise Pollution And Control Strategy.*

Justeru itu maka terhasilnya kajian produk ini dimana ia bertujuan untuk mengatasi masalah yang dihadapi oleh pelajar dan juga pensyarah JKA iaitu kesukaran untuk melaksanakan proses pengajaran dan pembelajaran( PdP) akibat terganggu dengan bunyi bising yang berterusan apabila pelajar melaksanakan aktiviti amali di Bengkel Jalan raya menggunakan *Los Angeles Resistance Abrasion Machine*. Penghasilan produk inovasi ini mampu mengatasi masalah yang dihadapi oleh pelajar dan kakitangan JKA dan Kawasan sekitarnya.

## **2. Pernyataan masalah**

Hasil temu bual bersama En. Mohamad Khairi Bin Mat Yaacob, merangkap Penyelia Bengkel Hidraulik dan juga pensyarah pada 29 September 2022 yang lalu, didapati mengalami gangguan bunyi bising yang terlalu kuat sehingga mampu mengganggu proses pengajaran dan pembelajaran yang sedang dilaksanakan. Kesan hingar yang dikeluarkan oleh *Los Angeles Resistance Abrasion Machine* boleh mendatangkan masalah pendengaran yang serius kepada telinga manusia serta suara pensyarah menjadi tidak begitu jelas dan perlahan semasa mengajar. Melalui kajian terdahulu menggunakan aplikasi *Sound Meter* didapati mesin tersebut menghasilkan bunyi kuat yang berterusan dan bacaan bunyi tersebut telah melebihi had aras pendengaran yang ditetapkan dengan nilai yang melebihi 80 dBA.

Menurut The Malaysian National Society of Audiologists (MANSA) *in collaboration with Audiology and Speech-Language Pathology Students' Society (Audissy) IIUM* bahawa kekuatan bunyi yang berterusan melebihi 80 dBA mampu menjejaskan kesihatan telinga dan memberi impak negatif terhadap pendengaran serta mampu merosakkan gendang telinga.

## **3. Objektif kajian**

Objektif utama kajian ini dijalankan adalah untuk :

- i. Untuk menghasilkan alat penebat bunyi bagi menghasilkan alat penebat bunyi pada mesin *Los Angeles Resistance Abrason*.
- ii. Menguji keberkesanan produk yang dihasilkan dengan mengukur kekuatan bunyi mesin selepas produk dihasilkan menggunakan aplikasi *Sound Meter*.

#### 4. Skop kajian

Kajian ini dilaksanakan bagi mengurangkan kekuatan bunyi semasa aktiviti amali pelajar di Bengkel Jalan Raya, Jabatan Kejuruteraan Awam. Bahan-bahan yang digunakan untuk menghasilkan produk ini terdiri daripada bahan kitar semula iaitu span, fabrik kain terpakai, bekas telur, kayu dan lain-lain. Bagi menguji keberkesanan produk yang dihasilkan, penggunaan aplikasi *Sound meter* android di buat bagi mengukur kekuatan bunyi. Aplikasi *Sound meter* ini menggunakan android telefon mudah alih yang mana dapat membantu mengukur kadar bunyi bising alat sebelum dan selepas dipasangkan *Stargazer Sound Insulation (SSI)*. Aplikasi ini dapat mengukur kekuatan bunyi dalam unit *Decibel meter (dBA)*.

#### 5. Kajian Literatur

##### 5.1 Pengenalan

Kajian ini dijalankan untuk mengkaji pencemaran bunyi di sekitar kawasan kajian. Kesemua proses ini dilakukan secara berperingkat supaya produk akhir dapat memnuhi piawaian kajian. Selain itu, ia juga dapat membantu pelajar, pensyarah dan pengguna sekitar untuk menjaga pendengaran telinga. Produk ini sangat mudah digunakan kerana reka bentuk yang dibuat mengikut kehendak pengguna dan bahan yang digunakan juga ringan memudahkan untuk diselenggara. Seterusnya, produk yang dibuat menggunakan bahan kitar semula dapat mengurangkan pencemaran alam sekitar dan kos yang ditanggung adalah rendah.

Menurut Prof. Madya Dr. Zaiton Harun (2020) dalam utusan bertarikh 25 November 2020, 9:55 pagi keterdedahan kepada bunyi yang tinggi di dalam bilik darjah juga mengakibatkan para guru terpaksa meninggikan aras suara sebanyak 20-30 dBA berbanding aras bunyi bising semasa mengajar agar boleh didengari oleh murid-murid secara optimal. Ini bermakna seseorang guru mengajar dengan aras suara pada tahap melebihi 80 dBA disepanjang tempoh masa pengajaran mereka. Sebagai akibatnya, guru-guru tersebut boleh mengalami gangguan kesihatan fizikal dan mental seperti kehilangan suara, sakit tekak, keletihan mental, berasa marah dan cemas. Selain itu, mereka juga boleh hilang fokus dan semangat seterusnya menjejaskan profesion sebagai pendidik.

Menurut Siti Musliha dan rakan (2012) Kebisingan daripada operasi industri adalah daripada mesin dan peralatannya. Paras tekanan bising industri adalah sukar ditentukan disebabkan saiz dan bentuk pelbagai industri di samping mempunyai gelombang pelbagai sumber kebisingan.

##### 5.2 Peraturan dan Kawalan Sekatan

Menurut Mansor Ibrahim dan rakan (1997), dalam Akta Kualiti Alam Sekeliling 1974, di bawah Seksyen 23, individu yang didapati tidak berlesen yang menyebabkan atau mengeluarkan bunyi bising yang lebih kuat bahana, akan dikenakan denda tidak lebih daripada RM100,000 atau penjara selama tempoh tidak lebih dari lima tahun atau kedua-duanya sekali dan denda tambahan tidak lebih dari RM500 sehari bagi setiap hari kesalahan itu diteruskan selepas diberikan notis oleh Ketua Pengarah supaya berhenti melakukan perbuatan yang menyebabkan bunyi bising itu berlaku.

Menurut Mansor Ibrahim dan rakan (2001), dalam Akta Kilang dan Jentera, 1967 memaklumkan bahawa pekerja industri pula dilindungi pekerja daripada bahaya kehilangan pendengaran semasa bekerja akibat daripada bunyi bising di tempat kerja.

Menurut Prof. Madya Dr. Zaiton Harun (2020) dalam utusan bertarikh 25 November 2020, 9:55 pagi, dapatan kajian tersebut menunjukkan, aras bunyi pada ketika itu melebihi 55 dBA iaitu had bunyi berterusan setara, LAeq piawai yang dibenarkan oleh Pertubuhan Kesihatan Sedunia (WHO).

### 5.2.1 Punca pencemaran bunyi

Menurut E. & F.N. Spon (2002), terdapat empat kategori pencemaran bunyi iaitu kebisingan selang-seli, kebisingan selenjar, kebisingan fluktuasi dan bunyi lantunan. Kesemua kategori itu ada dalam kehidupan sekeliling kita ataupun aktiviti ekonomi semasa dalam Malaysia ini. Contohnya, kenderaan yang lalu lalang setiap hari termasuklah kenderaan awam seperti keretapi, komuter dan kapal terbang yang juga menyumbang pada pencemaran udara.

### 5.2.2 Kesan pencemaran bunyi

Menurut Mansor Ibrahim dan rakan (1997), Bunyi bising yang keterlaluan boleh menyebabkan bermacam-macam masalah kesihatan. Contohnya gangguan ketika tidur, sakit jantung, gangguan psikologi, gangguan komunikasi, produktiviti dan menyebabkan pekak. Telinga merupakan organ yang sensitif, boleh menyebabkan rasa tidak tenang dan tertekan. Malah ia juga boleh mengganggu proses pembiakan dan habitat haiwan yang ada di sekeliling.

## 6. Metodologi Kajian

Metodologi projek adalah meliputi kaedah dan pendekatan yang digunakan untuk mencapai objektif dan matlamat projek. Metodologi projek menjadikan projek yang dijalankan lebih bersistematik dalam mencapai objektif. Metodologi projek yang digunakan dalam projek yang dijalankan dan telah dirancang dengan teratur. Bab ini juga akan membincangkan dengan terperinci beberapa perkara penting dalam metodologi dan strategi yang digunakan dalam menyiapkan projek ini.

Mesin tersebut adalah sebuah mesin yang digunakan untuk ujian kehausan agregat yang digunakan dalam bengkel jalanraya. Mesin ini disediakan dan digunakan secara terbuka. Apabila alat atau mesin ini beroperasi, ia akan mengeluarkan bunyi bising yang boleh mengganggu persekitaran. Bunyi tersebut dikeluarkan melalui tong drum yang berpusing mengikut kelajuan yang dihendaki. Masa pengeluaran bunyi ini juga berterusan mengikut masa yang diperlukan semasa ujikaji. Justeru itu, penghasilan satu produk alat penutup mesin yang dipanggil *Stargazer Sound Insulation (SSI)* untuk mengurangkan bunyi bising pada *Los Angeles Resistance Abrasion Machine* tersebut. SSI boleh mengurangkan bunyi bising yang boleh mengganggu suasana sekeliling tempat tersebut. Satu kelebihan mencipta penutup *Stargazer Sound Insulation (SSI)* ini adalah bahan yang digunakan itu kebanyakannya bahan kitar semula. Kos untuk melaksanakan *Stargazer Sound Insulation (SSI)* ini adalah lebih murah kerana banyak menggunakan barang kitar semula. Produk ini dihasilkan bagi membantu pengguna terutama kepada pihak kakitangan dan pelajar JKA dalam mengurangkan bunyi bising dan tidak mengganggu suasana sekeliling seperti proses pembelajaran PdP dan sebagainya. Projek ini terdiri daripada gabungan beberapa bahan kitar semula dan bahan kayu yang boleh mengukuhkan lagi produk tersebut supaya produk itu boleh digunakan dengan sempurna.



## 6.1 Rekabentuk produk

Reka bentuk kajian adalah penting bagi sesuatu kajian sebagai panduan untuk memastikan objektif kajian tercapai. Kajian yang dijalankan ini adalah bertujuan untuk melihat sejauh mana kesan penggunaan produk *Stargazer Sound Insulation (SSI)* sebagai bahan bantu mengurangkan kesan bunyi di sekitar kawasan yang terlibat.

Rekabentuk produk ini dihasilkan bagi mengurangkan kadar bunyi bising yang dikeluarkan oleh *Los Angeles Resistance Abrasion Machine*. Alat ini digunakan sebagai salah satu ujian bagi mendapatkan keputusan kehausan agregat yang menjadi salah satu ujian amali dalam subjek DCC 30112 (*Geotechnic and Highway Laboratory*).

Langkah pertama untuk merekabentuk produk ini ialah dengan membuat rekabentuk produk dengan menggunakan lakaran saiz dan bentuk. Kemudian pengumpulan bahan diperlukan berdasarkan rekabentuk yang dicipta. Bahan-bahan tersebut terdiri daripada bahan kitar semula dan bahan yang mudah didapati dengan harga yang rendah seperti sarang telur, span, gabus, cat, berus dan lain-lain. Langkah seterusnya ialah dengan menghasilkan kabinet atau perabot dengan menggunakan 3 keping playwood bersaiz 4 x 8 kaki dan tebalnya ialah 9 mm. Selepas itu, kerja-kerja mengecat dan mencantikkan lagi produk. Akhirnya ujian *sound meter* akan dijalankan keatas produk bagi mengetahui keberkesanan produk yang dihasilkan.



**Rajah 6.1:** Kerja-kerja menampal dinding *SSI* dengan gabus, sarang telur dan span.



**Rajah 6.2:** Salah seorang anggota kumpulan sedang memasang pintu SSI.



**Rajah 6.3:** Kerja-kerja mengecat.

## 7. Analisis Data

**Jadual 1.0 :** Keputusan Ujian *sound meter* menggunakan telefon mudah alih.

Note	Result Value			Justification
Distance (meter)	0	15	23	
Standard World Health Organization (WHO) (dBA)		<70		The sound on <i>Los Angeles Resistance Abrasion Machine</i> is reduce when using SSI . It mean that the tool is <u>allowed</u> according to standard and can reduce noise.
Los Angeles Resistance Abrasion Machine (dBA)	81	77	72	
Los Angeles Resistance Abrasion Machine With Product SSI (dBA)	69.8	58	55	
Mean (dBA)	11.2	19	17	
	↓	↓	↓	

Berdasarkan Jadual 1.0 di atas, menunjukkan bahawa hasil ujian *sound meter* menggunakan telefon mudah alih. Didapati bahawa *Los Angeles Resistance Abrasion Machine* telah mengeluarkan bunyi bising melebihi 80 dBA namun selepas produk *Stargazer Sound Insulation (SSI)* dihasilkan maka didapati bahawa terdapat pengurangan bunyi bising. Perbezaan nilai kekuatan bunyi bising telah menurun sebanyak 11.2 dBA pada jarak 0 meter manakala pada jarak 15 meter ialah pengurangan sebanyak 19 dBA dan akhir sekali pada jarak 23 meter iaitu di luar bengkel jalan raya iaitu pengurangan sebanyak 17 dBA. Ini menunjukkan bahawa terdapat pengurangan bunyi yang jelas di mana ia dapat membantu kakitangan dan pelajar dalam aktiviti PdP di dalam Bengkel Jalan Raya dan sekitarnya.

Daripada hasil kesahan produk yang disahkan oleh Pensyarah En.Mohamad Khairi bin Mohd Yaakob selaku penyelia bengkel hidraulik memaklumkan bahawa terdapat pengurangan bunyi berlaku semasa pengendalian atau pengoperasian alat tersebut. Justeru itu maka terbukti bahawa alat *Stargazer Sound Insulation (SSI)* ini berkesan digunapakai di Bengkel Jalan Raya bagi mengurangkan bunyi bising.

## 8. Kesimpulan

Setiap projek yang dibangunkan mempunyai kepentingan dan objektifnya tersendiri, begitu juga dengan *Stargazer Sound Insulation (SSI)*. Berdasarkan kesimpulan yang telah dibuat, didapati projek ini diterima baik oleh warga JKA. Ini kerana *SSI* telah berjaya membantu mengurangkan risiko hilang pendegaran dan menyebabkan gangguan semasa proses PdP berlangsung. Kajian produk yang dinamakan *Stargazer Sound Insulation (SSI)* ini terhasil kerana ia mampu mengurangkan bunyi bising malah mengurangkan pencemaran bunyi. Namun begitu penambahbaikan perlu di buat terutama semasa ujian *sound meter* menggunakan telefon mudah alih dijalankan. Antara penambahbaikan yang perlu ialah peralatan seperti mikrofon digunapakai semasa ujian dijalankan supaya bunyi-bunyian lain tidak menjejaskan keputusan ujian. Begitu juga dengan bahan-bahan yang digunakan perlulah menggunakan bahan kitar semula bagi mengurangkan kos bahan dan lain-lain lagi. Oleh itu, diharapkan projek ini dapat diteruskan agar dapat di guna sama oleh kakitangan dan pelajar Jabatan Kejuruteraan Awam (JKA) serta dapat di komersialkan secara meluas. Dengan ini, marilah bersama kita membantu untuk membangunkan ekonomi Malaysia dengan penghasilan inovasi yang lebih hebat.

## Rujukan

- Abdel-Mohsen, O. Mohamed, Evan (2020). Pollution Assessment for Sustainable Practices in Applied Sciences and Engineering. Butterworth Heinemann.
- Adib Danial (2 Jun 2021). Pencemaran-bunyi-mengganggu-ketenteraman-penduduk-di-sekitar-selangor. <https://sites.google.com/view/beritadimensi/utopia/pencemaran-bunyi-mengganggu-ketenteraman-penduduk-di-sekitar-selangor>
- E. & F.N. Spon (2002). Noise Control in Industry, Third Edition. Sound Research Laboratory. CRC Press.
- Mackenzie Davis, David Cornwell (2012). Introduction to Environmental Engineering 5TH ED. McGraw Hill.
- Mat Lazim Zakaria (2005). Bahan Dan Binaan. Dewan Bahasa Dan Pustaka. Skudai, UTM.
- Mansor Ibrahim (1997). Pencemaran Bunyi Bising. Universiti Teknologi MARA.
- Rohayu Arifin, Mohamad isa Hashim, Mohamad Suhaily Yusri Che Ngah, Nasir Nayan Yazid Saleh (2015). Tahap kebisingan trafik dan kesannya terhadap persekitaran pengajaran-pembelajaran sekolah di pusat bandar Kuala Terengganu.
- Siti Musliha dan Jemilah Binti Awang Kechik (2012). Pencemaran Air, Bunyi dan udara. Pendidikan Alam sekitar. Institut Perguruan Persekutuan Pulau Pinang.
- S P Singal (2005), Noise Pollution And Control Strategy. Alpha Scince International LTD. Oxford.
- Vernon John (1997). Pengenalan Kepada Bahan Kejuruteraan. UTM.
- Who Health Organisation. (2013). *The diabetes statistics of the world*. Brooklyn, NY: WHO Press.
- my/teras/alamsekitar/Documents/Akta\_Kualiti\_Alam\_Sekeliling\_1974\_ACT\_127.pdf
- Prof. Madya Dr Zaiton Haron (25 November 2020, 9:55 am) <https://www.utusan.com.my/gaya/sains/2020/11/sejauh-mana-bilik-darjah-kedap-udara-mampu-direalisasikan/>

# Designing and Developing Web Based System for E-Permit at Majlis Perbandaran Dungun

Nor Azlina Binti Ibrahim\*, Muhammad Qaid Haziq Bin Mohd Iqbal, Najib Farhan Bin Faisal @ Ahmad Faisal, Muhammad Khairul Anuar Bin Johari

Department of Information Communication and Technology, Politeknik Sultan Mizan Zainal Abidin, 23000  
Dungun Terengganu

\*Corresponding author E-mail: nor.azlina@psmza.edu.my

## Abstract

E-Permit System is an innovation implemented in the Majlis Perbandaran Dungun (MPD). Permits are typically required for various purposes to ensure that certain standards, regulations, and safety measures are met. The objectives of this innovation were developed to identifying data and user requirements for the E-Permit System, to designing and developing the E-Permit System and to conducting testing on the E-Permit System. This system was developed using PHP programming language, XAMPP web server, MySQL database, Bootstrap and Cascading Style Sheets (CSS). Agile methodology is used in the development of this system which consists of planning, designing, developing, testing, organize and launching phases. Unit Testing Plan (UTP), Integration Testing Plan (ITP) and Unit Acceptance Testing (UAT) have been conducted on the system. The UTP and ITP result was as expected, indicating that it was carried out according to the plan based on the given input. Based on the UAT analysis, the overall mean is 4.75. As conclusion, the system has simplified the process of document storage and retrieval, allowing user work more efficiently. The system maintains data integrity and security by centralizing information.

*Key Words: Permit, Web Based, System*

## 1. Introduction

A permit is an official document or authorization issued by a government authority or regulatory body that grants permission or legal approval for specific activities, actions, or projects. Permits are typically required for various purposes to ensure that certain standards, regulations, and safety measures are met. The specific requirements and processes for obtaining permits can vary widely depending on the jurisdiction and the nature of the activity or project. Failing to obtain the necessary permits when required can result in legal consequences, fines, or the suspension of the activity in question. It's important to check with the relevant government authorities or agencies to understand and comply with permit requirements in certain areas (Garis Panduan Permohonan Lesen Dan Permit Iklan Luar, 2024).

An E-Permit System is a regulatory framework designed to streamline and consolidate various environmental permits and approvals into a single, integrated permitting process. The goal of an E-Permit System is to simplify and harmonize the permitting process for activities that may have multiple environmental impacts, such as industrial operations, construction projects, or facilities that release emissions or pollutants into the environment. This system helps achieve better coordination among regulatory agencies and reduces administrative burdens for permit applicants.

It's important to note that the specific structure and implementation of an E-Permit System can vary from one jurisdiction to another, as it depends on the local or national regulatory framework and the types of activities it covers. Such systems are often used to regulate complex industrial operations, large construction projects, or facilities with significant environmental impacts. In practice, the success of an E-Permit System depends on effective communication and cooperation among regulatory authorities, businesses, and stakeholders to ensure that environmental goals are met while simplifying the permitting process.

This E-Permit System will help an applicant to make an application for the permit without go to the Majlis Perbandaran Dungun (MPD) and make permit manually. So, in this system the applicant or user need to open the MPD websites to do the applications for the permit. After user finish their applications, staff from MPD in IT department will get notify about the applications and they will check the applications that the user sent or requests. Furthermore, one of the primary advantages of an E-Permit System is its ability to enhance efficiency. E-Permit System is designed to streamline the permitting process, minimizing duplication of efforts and paperwork, ultimately resulting in faster approval times for permit applications.

## **2. Problem Statement**

There is currently no online website available for permit applications, whereas in other areas, such a platform already exists. This discrepancy can pose challenges for dealers in Dungun who are required to visit the MPD in person to apply for permits in advance, resulting in both time and cost inefficiencies. Additionally, some individuals forget the status of their permits and their expiration dates, which can lead to compliance issues and potential penalties.

## **3. Objective**

The proposed studies are listed as below:

- i. To identify data and user requirements for the E-Permit System.
- ii. To design and develop the E-Permit System.
- iii. To conduct testing on the E-Permit System.

## **4. Scope**

The system is designed to serve multiple user groups, including Admin, the staff of MPD, and applicants. Each user need to access the system through a distinct interface upon login. This project system has a primary focus on facilitating online permit applications and providing access to data received by the MPD. It streamlines the permitting process and transparency for all stakeholders involved.

## **5. Literature Review**

### **5.1 Introduction**

In the contemporary regulatory landscape, the management of permits, licenses, and regulatory compliance has emerged as a critical concern for both governmental bodies and private enterprises. An E-Permit System represents a fundamental paradigm shift in how regulatory authorities administer permits and how businesses and individuals interact with the regulatory ecosystem. This literature review embarks on a comprehensive exploration of the multifaceted dimensions of E-Permit System, analysing its origins, evolution, implementation, and impact within various sectors.

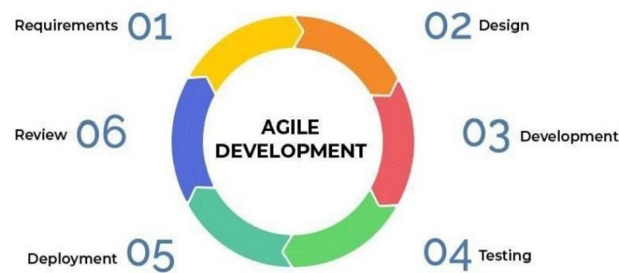
The fundamental premise of an E-Permit System revolves around the consolidation of disparate permitting processes into a unified, coherent system. This system aims to streamline administrative workflows, enhance transparency, improve regulatory compliance, and facilitate sustainable development. As governments around the world grapple with growing regulatory complexity, environmental concerns, and economic imperatives, the E-Permit System has emerged as a pivotal tool to achieve regulatory efficiency while balancing the interests of public safety, environmental protection, and economic growth. Based on Table 1 below, there are comparison websites from Majlis Perbandaran Klang, Majlis Perbandaran Sepang and Majlis Perbandaran Kajang.

**Table 1:** Comparison websites from Majlis Perbandaran (Bernama, 2020 & Bernama, 2021)

System / Features	MAJLIS PERBANDARAN KLANG	MAJLIS PERBANDARAN SEPANG	MAJLIS PERBANDARAN KAJANG
USER-FRIENDLY	Yes	Yes	Yes
WEBSITES	Yes	Yes	Yes
FILE ARRANGEMENT	Nothing	Excellent	Good
HELP PAGES	Manual	Chatbot	Not Available
INTERFACE	Less Attractive	Attractive	Not Attractive

## 6. Methodology

The Agile Model is an incremental and iterative process of software development (Noor Khatini Mohamad @ Khalid, 2019). It defines each iteration's number, duration, and scope in advance. Every iteration is considered a short frame in the Agile process model, which mostly lasts from two to four weeks. Agile Model divides tasks into time boxes to provide specific functionality for the release (Alsaqqa, 2020). Each build is incremental in terms of functionality, with the final build containing all the attributes. The division of the entire project into small parts helps minimize the project risk and the overall project delivery time.



**Figure 1:** Agile Model

### 6.1 Logical Design

Figure 2 shows the context diagram of E-Permit System. Context diagrams show the interactions between a system and other actors (external factors) with which the system is designed to interface. System context diagrams can clarify the context which the system will be part of. They are used early in a project to get agreement on the scope and can be included in a requirements document. A context diagram shows the entire system as a single process.

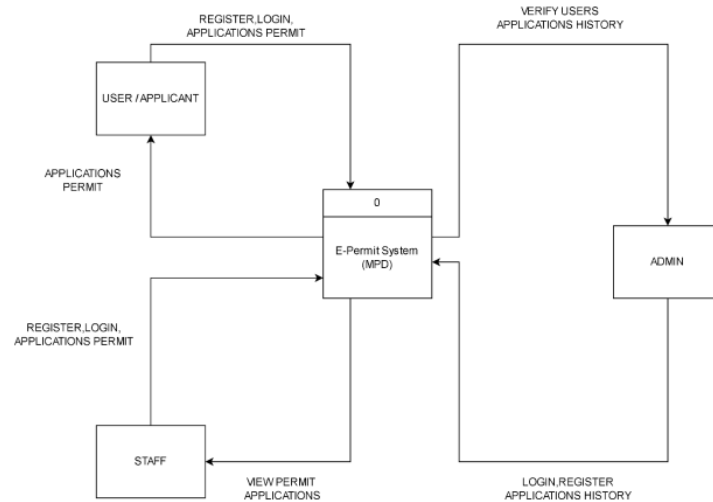


Figure 2: Context diagram of E-Permit System

### 6.2 Physical Design

Physical design relates to the actual input and output processes of the system. It focuses on how data is entered into a system, verified, processed, and displayed as output. It produces the working system by defining the design specification that specifies exactly what the candidate system does. It is concerned with user interface design, process design, and data design. Figures 3, 4, 5 and 6 shows the example of physical design of E-Permit System.



Figure 3: Main Menu Interface

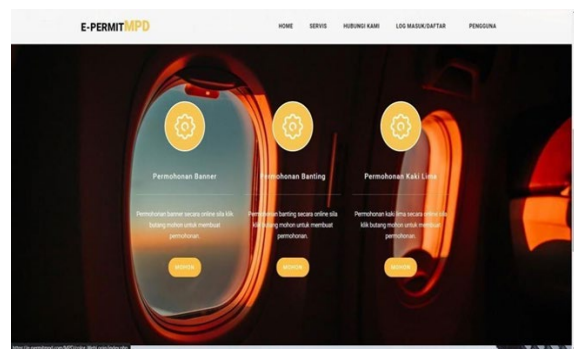


Figure 4: Application Form

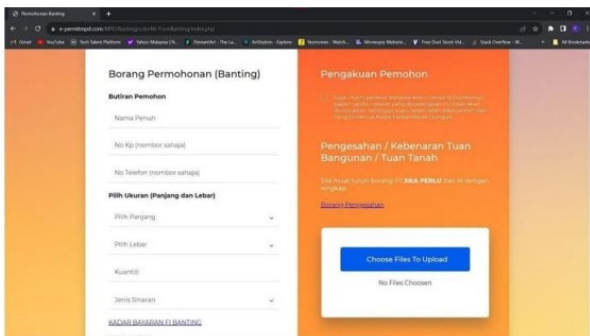


Figure 5: Bunting Form

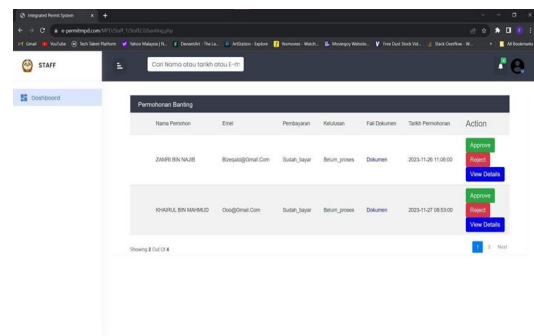


Figure 6: List of Application



### 6.3 Hardware and Software Requirement

This system was developed using PHP programming language, XAMPP web server, MySQL database, Bootstrap and Cascading Style Sheets (CSS).

## 7. Data Analysis

After the development phase is completed, unit testing has been done to the process to test the smallest functional unit of code.

### 7.1 Unit Testing

The purpose of unit testing is to validate that each unit of the software code performs as expected. Table 2 shows the analysis of unit testing that has been done. Based on the analysis, it can be concluded that E-Permit passes the testing overall.

**Table 2:** Unit Testing Analysis

User Scope	Process	Pass (%)	Fail (%)
<i>Admin</i>	Login	100	0
	Search form application	100	0
	Add Banner/Bunting/Kaki Lima Form	100	0
	View Banner/Bunting/Kaki Lima Form	100	0
	Update Banner/Bunting/Kaki Lima Form	100	0
	Delete Banner/Bunting/Kaki Lima Form	100	0
	Add notification		
	View notification		
<i>Applicant</i>	Register	100	0
	Login	100	0
	Add Banner/Bunting/Kaki Lima Form	100	0
	View Banner/Bunting/Kaki Lima Form	100	0
	Update Banner/Bunting/Kaki Lima Form	100	0
	Delete Banner/Bunting/Kaki Lima Form	100	0
	View notification		
<i>Staff</i>	Login		
	Search form application	100	0
	Add Banner/Bunting/Kaki Lima Form	100	0
	View Banner/Bunting/Kaki Lima Form	100	0
	Update Banner/Bunting/Kaki Lima Form	100	0
	Delete Banner/Bunting/Kaki Lima Form	100	0
	Add notification		

### 7.2 Integration Testing

Integration Testing is a collection of integration tests that focus on functionality. The purpose of this test is to expose defects in the interaction between these software modules when they are integrated. Table 3 shows the analysis of Integration Testing that has been done.

**Table 3:** Integration Testing Analysis

No	Test CaseName	Test Procedure	Expected Result	Pass (%)	Fail (%)
1	Home button	Click the 'home' button to go back to the home page.	Stay at the homepage.	100	100
2	Menu Button	Click the 'Menu Button' button to preview drop downlist	Menu list will appear.	100	100
3	Login button	Click the 'Login' button to access the system	Login popup page will appear.	100	100
4	Kaki Lima Application Button	Click the Kaki Lima button to go Kaki Lima page	Kaki Lima page will appear.	100	100
5	Banner Application Button	Click the Banner button to go to Banner page	Banner page will appear.	100	100
6	Bunting Application Button	Click the Bunting button to go to Bunting page	Bunting page will appear.	100	100

### 7.3 Unit Acceptance Testing

Unit Acceptance Testing (UAT) is the final stage of final stage of any development process to determine that the software does what it was designed to do in real-world situations (Nasir, N., 2021). The testing team of end-users that includes stakeholders and representatives of every group in the organization will test the software to see if the product is acceptable for release or not. A set of questionnaires was given the UAT testing done. There are 2 criteria which are user interface and system functionality. Table 4 show the analysis of average mean score for each criterion.

**Table 4:** Analysis Unit Acceptance Testing

Criteria	Mean Score
User Interface	4.70
System Functionality	4.80
Average mean	4.75

## 8. Conclusion

In conclusion, the objective of this study, which is to develop a E-Permit system and identify the level of effectiveness of the developed system, has been achieved. A-Permit also give more efficient, organized, and efficient information management as well as saving work time that needs to be allocated compared to the previous manual work process. Based on Analysis Unit Acceptance Testing, the system is acceptable for release. As an additional suggestion, there are a few modules can be added such as add an online payment. However, the system also can be able to be upgraded in terms of functionality and usability in the future so that it can be applied more effectively and efficiently.

## References

- Alsaqqa, S., Sawalha, S., & Abdel-Nabi, H. (2020). Agile Software Development: Methodologies and Trends. *International Journal of Interactive Mobile Technologies (iJIM)*, 14(11), pp. 246–270. <https://doi.org/10.3991/ijim.v14i11.13269>
- Bernamea (2021). MPK MPKlang values the personal data of our customers and ensures that all data collected is in line with the PDPA (Personal Data Protection Act 2010). <https://iportal.mpklang.gov.my/PermitOnline/SPIS/mobile/index.html>
- Bernamea (2020) Kajang Municipal Council, creating a conducive residence by providing municipal services and infrastructure towards a quality life. <https://www.mpkj.gov.my/ms/mpkj/sumber/muat-turun-borang/unit-pusat-setempat-osc-permohonan-online-pelan-bangunan-dan-permit>
- Bernamea. (2021) MP Sepang is a Local Authority authorized under Act.171 to provide municipal services to all Sepang citizens <https://www.mpsepang.gov.my/permit-lesen/>
- Garis Panduan Permohonan Lesen Dan Permit Iklan Luar (2024) . (n.d.). [https://mpd.terengganu.gov.my/images/GP\\_PELESENAN/MPD\\_GP\\_Lesen\\_dan\\_Pemit\\_Iklan\\_Luar\\_2024\\_compressed.pdf](https://mpd.terengganu.gov.my/images/GP_PELESENAN/MPD_GP_Lesen_dan_Pemit_Iklan_Luar_2024_compressed.pdf)
- Nasir, N. (2021). Acceptance Testing in Agile Software Development - Perspectives from Research and Practice (Dissertation). Retrieved from <https://urn.kb.se/resolve?urn=urn:nbn:se:bth-21141>
- Noor Khatini Mohamad @ Khalid, H. S. (2019). Model Penerimaan Metodologi Agile Bagi Pembangunan Sistem Maklumat Di Sektor Awam Malaysia. PS-FTSM-2019-016, 1–14.

## Folding Table Chair

**Mohd Sabri Bin Hussin\*, Daniel Essayue Idham Bin Abdullah, Muhammad Khairul Fakhri Bin Roslan, Muhammad Asraaf Bin Sulhaizam, Amirul Haziq Bin Zulkifli**

Department of Mechanical Engineering, Politeknik Sultan Mizan Zainal Abidin, 23000 Dungun Terengganu

\*Corresponding author E-mail: sabri.hussin@psmza.edu.my

### Abstrak

Projek ini bertujuan untuk mereka bentuk dan membina “*Folding Table Chair*” atau meja lipat dan kerusiurut. Tercetusnya idea untuk menginovasikan meja dan kerusi di tempat belajar dan tempat beristirehat kepada meja dan kerusi yang mempunyai ciri tersendiri adalah apabila kami melihat meja yang digunakan pelajar untuk menulis adalah sama dengan meja yang digunakan untuk berehat sama juga dengan kerusi. Selalunya, pada ruang belajar tidak mempunyai kerusi dan meja yang mencukupi bagi memberi ruang untuk melakukan kerja maka apabila pelajar ingin menulis diatas meja serta duduk mereka perlu mencari kerusi dan meja yang berasingan. Kami berfikir untuk menghasilkan sebuah meja dan kerusi yang digabungkan dan tempat pengurut bagi memudahkan serta keselesaan pelajar dan pekerja semasa belajar ataupun beristirehat.

*Kata Kunci: meja lipat, tempat pengurut, menginovasikan meja, keselesaan pelajar*

### 1. Pengenalan

*Folding Table Chair* penyelesaian masalah dari segi ruangan dalam atau luar tempat rehat dapat dikurangkan. Jika kita lihat pada masa kini, masih kurang teknologi yang disediakan pada meja kerusi lipat dan tidak ramai lagi yang menggunakan meja kerusi lipat pada ruang yang ada. Tumpuan yang ingin dititikberatkan adalah untuk memaksimumkan penggunaan ruang dan memiliki teknologi pada satu produk sahaja. Tumpuan ini telah membawanya idea untuk membina meja dan kerusi yang boleh dilipat serta mesinurut yang dapat berfungsi menggunakan batteri. Meja kerusi lipat dan mesinurut adalah satu kaedah bagi seseorang merehatkan diri mereka. Dengan kemajuan teknologi, penyelidikan boleh meneroka cara teknologi boleh disepadukan ke dalam meja dan kerusi lipat untuk meningkatkan fungsi dan kemudahan penggunaan. Contohnya, meja dan kerusi dengan ciri lipatan dan mesinurut yang ada pada belakang meja itu untuk menenangkan diri dari tekanan.

#### 1.1 Penyataan Masalah

Kita sering dengar dan lihat ramai orang mengadu sakit dan lenguh di bahagian pinggang dan tulang belakang. Masalah ini biasanya dihadapi oleh pekerja yang kerja di pejabat dan pelajar di sekolah dalam tempoh yang lama. Masalah yang kita tahu adalah dari segi keselesaan dan kemudahan. Selain itu, cara duduk seseorang boleh menyebabkan tulang belakang menjadi bengkok. Malah, kita sering tengok apabila seseorang itu duduk dan boleh lihat badan mereka ketika duduk itu sangat berbeza. Oleh itu, untuk mengelakkan perkara itu berlaku, kami telah melakukan projek meja dan kerusi yang digabungkan serta tempat pengurut badan akan dapat membantu menyelesaikan sedikit sebanyak masalah yang dihadapi oleh mereka.

## 1.2 Objektif Kajian

Tujuan projek ini adalah untuk mereka bentuk sebuah meja dan kerusi boleh lipat dan senang dibawa serta mempunyai alat pengurut belakang.

## 1.3 Skop Kajian


Bagi mencapai objektif ini, kami telah menetapkan beberapa skop projek seperti di bawah:-

- i. Projek ini menggunakan besi jenis hollow dan plywood jenis multipeks.
- ii. Alat pengurut yang menggunakan sumber bateri (12V 5A) dan motor (12V 1.5-2.0A)
- iii. Meja ini diperbuat dari pada besi keluli lembut.
- iv. Meja ini mempunyai tempat pengurut badan.
- v. Meja ini berukuran 123 cm panjangnya dan kelebarannya 57 cm.

## 2. Kajian Literatur

### 2.1 Pengenalan

Kajian literatur yang kami jalankan ini akan membincangkan sedikit sebanyak mengenai meja lipat biasa yang kami jalankan merupakan dasar permasalahan yang timbul hasil daripada pemerhatian terhadap keselesaan pengguna.

<p><b>Foldable Picnic Table</b></p> 	9.2 kg	160 kg	<p>Table 85.5 x 5 x 66.55cm</p> <p>Chair 30 x 27 x 40 cm</p>	Tahan lama dan lasak	Mudah rosak jika nipis
---	--------	--------	--	----------------------	------------------------

**Rajah 1:** Meja Lipat yang biasa digunakan dalam pasaran

### 2.2 Folding Table Chair

*Folding Table Chair* yang kami cipta dan ingin diinovasikan adalah dari sebuah *meja lipat picnic* dipasaran. *Folding Table Chair* adalah asalnya sebuah *meja dan kerusi* yang asalnya tak boleh lipat. Ia telah dicipta dengan kerangka besi *mild steel hollow*. Kemudian direka dengan sendi agar boleh lipat dan bahagian atas meja diletakkan playwood. Pada bahagian kerusi diletakkan alat pengurut belakang biasa terdapat di pasaran dibaluti dengan kapas polyster fiber dan kain pembalut dan dijanakan kuasa eletrik sebuah bateri motorsikal 12 Volt. Apabila tidak digunakan ia boleh dilipat menjadi kerusi panjang untuk diduduki 4 orang. Untuk fungsi mengurut dilengkapi dengan suis disambung dengan bateri, pengguna hanya perlu menekan suis yang disertakan sahaja. Dalam satu masa boleh mengurut 2 orang sahaja sambil berehat.



PANDANGAN MEJA



PANDANGAN KERUSI

**Rajah 2:** Gambar projek *render* menggunakan *autodesk inventor*.

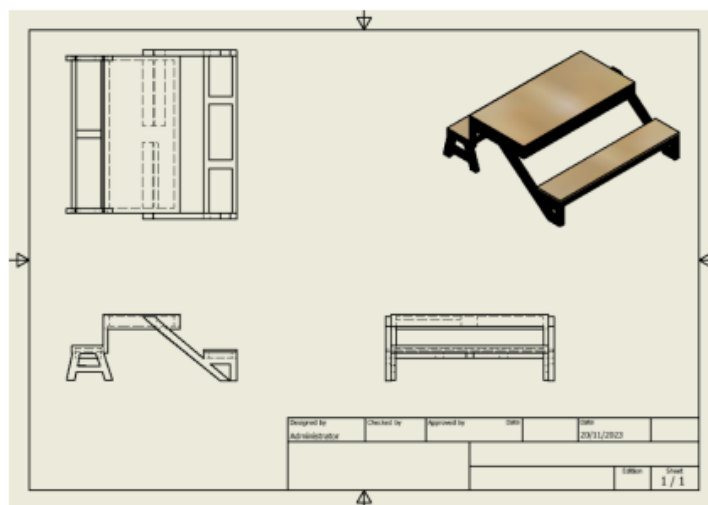
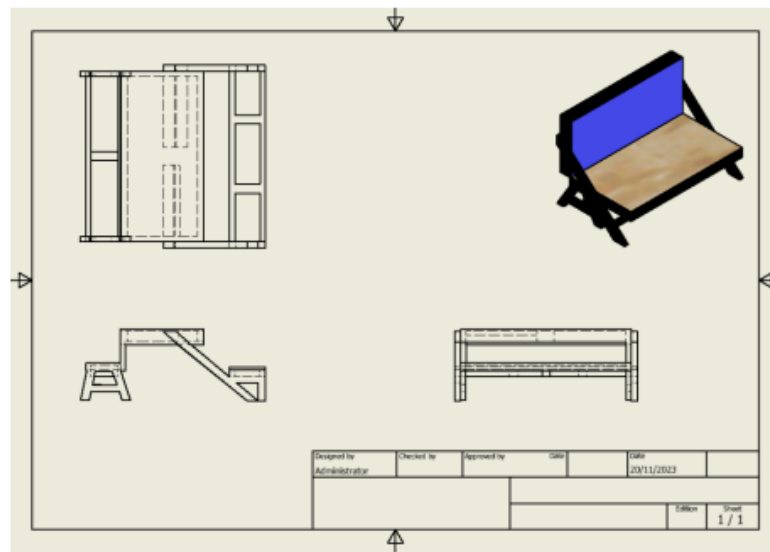


**Rajah 3:** Gambar projek sebenar bila dilipat



**Rajah 4:** Gambar projek sebenar bila tanpa dilipat

- Lukisan ortografik (drawing inventor)



**Rajah 5:** Gambar lukisan autografik menggunakan perisian Autodesk Inventor



Bill	Bahan	Kuantiti	Kos seunit (RM)	Kos keseluruhan (RM)
1.	MILD STEEL HOLLOW 1"X 2" x 20ft	4	20	200
2.	PLYWOOD BOARD 4ft x8ft 9mm	2	18	36
3.	Washer dan nut	4	1	4
4.	Skru	40	1	40
5.	Suis	1	1	1
6.	Mesinurut	2	24	48
7.	Bateri motor	1	50	50
8.	Wire	1	10	10
9.	Spray	8	7	56
10.	Wire MIG	1	25	25
11.	Wall sticker	5	2.40	16
<b>JUMLAH</b>				<b>RM 486</b>

**Rajah 6:** Kos keseluruhan projek *Folding Table Chair*

### 3. Dapatan Kajian

Analisis adalah penting untuk menentukan ketahanan projek dan bertujuan untuk menguji berapa banyak daya dan tekanan yang boleh disokong oleh Meja Lipat.

Formula:

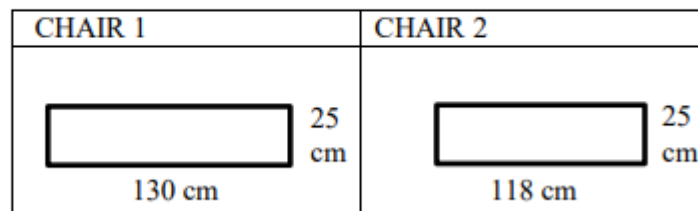
$$\Sigma F = mg \tag{1}$$

Di sini, F adalah *force*,  
m adalah jisim,  
dan g adalah graviti.

$$\sigma = F / A$$

*Pressure* merujuk kepada gaya yang diterapkan secara normal atau tegak lurus terhadap suatu penampang bahan. Di mana  $\sigma$  adalah *stress*, F adalah *force*, dan A adalah *area*.

#### Pressure



Calculation:

*Pressure on chair Force applied* = 588.6 N, 706.32 N, 686.7 N, 961.38 N

*Area (chair 1)* = 1.3 m x 0.25 m = 0.325 m<sup>2</sup>

*Area (chair 2)* = 1.18m x 0.25m = 0.295 m<sup>2</sup>

$$P (\text{khairul}) (\text{chair 1}) = 588.6\text{N}/0.325 \text{ m}^2 = 1811.077 \text{ N/m}^2$$

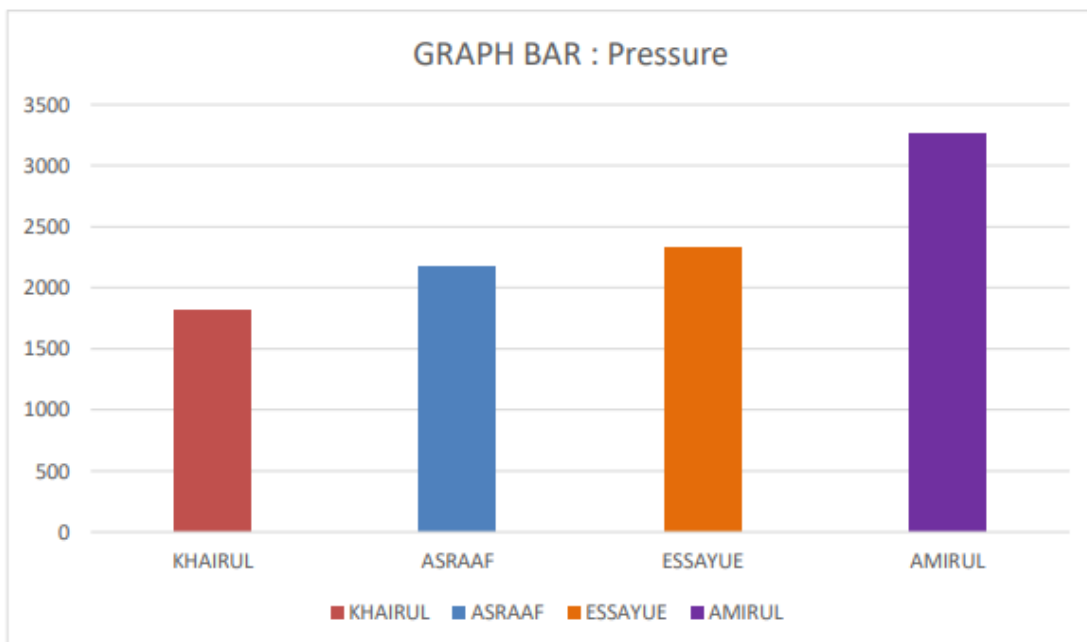
$$P (\text{asraaf}) (\text{chair 1}) = 706.32\text{N}/0.325 \text{ m}^2 = 2173.292 \text{ N/m}^2$$

$$P (\text{essayue}) (\text{chair 2}) = 686.7\text{N}/0.295 \text{ m}^2 = 2327.797 \text{ N/m}^2$$

$$P (\text{amirul}) (\text{chair 2}) = 961.38\text{N}/0.295 \text{ m}^2 = 3258.915 \text{ N/m}^2$$

**Result**

	Mass (kg)	Force (N)	Pressure (N/m <sup>2</sup> )
Khairul	60	588.6	1811.077
Asraaf	72	706.32	2173.292
Essayue	70	686.7	2327.797
Amirul	98	961.38	3258.915



**Rajah 7:** Graf berat peserta melawan tekanan yang dikenakan terhadap kerusi.

Dari kajian semakin berat peserta semakin besar tekanan yang dikenakan terhadap kerusi untuk menguji ketahanan kerusi.

#### 4. Kesimpulan

Secara kesimpulannya, penambahbaikan telah dibuat oleh kami pada *Folding Table Chair* ini. Produk ini boleh membantu dari segi penjimatan ruang kerana meja dan kerusi yang boleh dilipat, dan juga mesinurut untuk membantu mengurangkan lenguh dan memberi keselesaan pada pengguna. Kami mengharapkan produk kami ini dapat mencapai objektif dan skop yang telah kami buat. Dengan ini produk kami dapat berfungsi dengan baik dan mampu mencapai matlamat yang kami telah rancang. Selain itu, kekukuhan meja dan kerusi ini amat penting juga dari segi pemilihan material dan skill welding untuk membentuk produk ini. Seperti analisis di atas, produk kami berjaya untuk menampung 4 orang yang berbeza berat badannya. Analisis di atas amat penting untuk membuktikan kepada pengguna bahawa produk kami berkualiti dan mampu dijadikan sebagai perabot di ruang rehat.

##### 4.1 Cadangan

Penambahbaikan serta perubahan adalah dilakukan untuk menghasilkan projek mahupun produk yang baik dan berkesan. Walaupun pelaksanaan projek ini telah disiapkan dengan jayanya akan tetapi setiap penambahbaikan perlu dilaksanakan bagi memastikan projek ini menjadi sebuah produk yang sesuai digunakan pada mana-mana tempat. Pada pendapat pengkaji, beberapa aspek penambahbaikan perlu diambil kira melalui segi reka bentuk dan keselesaan *Folding Table Chair*. Antara ciri-ciri lain yang boleh ditambah adalah menambah kusyen pada tempat sandar kerusi bagi keselesaan kepada pengguna yang menggunakannya. Selain itu, ianya juga boleh digabungkan dengan projek sedia ada seperti menggabungkan projek ini dengan sistem pengurutan yang menggunakan motor penggerak berprestasi tinggi (secara linear) dan kneading massage head untuk meningkatkan lagi keselesaan pengguna. Seterusnya, aspek dari segi motor yang digunakan juga boleh ditambahbaikkkan dengan meningkatkan kuasa dan arus elektrik motor serta memperbesarkan lagi size kneading masage head bagi menambahkan kelajuan dan rasa mesinurut tersebut.

#### Rujukan

- Buku Panduan Penulisan Projek Pelajar*. Politeknik Malaysia Kementerian Pengajian Tinggi Edisi 2021.
- Shigley's mechanical engineering design / Richard G. Budynas, J. Keith Nisbett. 9th ed. p. cm. — (McGraw-Hill series in mechanical engineering) 2011.
- Pensyarah Politeknik Malaysia, Kajidaya Mesin, Jabatan Pengajian Politeknik 2002.
- J Blunt, N C Balchin. Health and Safety in Welding and Allied Processes. 5th Edition - March 28, 2002
- H. Harrison, T. Nettleton. Principles of Engineering Mechanics. 2nd Edition - March 17, 1994
- Peter Childs. Mechanical Design Engineering Handbook. 2nd Edition - November 24, 2018
- Richard Gentle, Peter Edwards, William Bolto. Mechanical Engineering Systems. 1st Edition - May 22, 2001

## EZ Grind Valve Machine

**Surniza Mohd Hilmin<sup>\*</sup>, Hafizul Razak, Haziq Firdaus Mohd Tarmizi, Iskandar Dzulkarnain Mohamad Fauzi, Muhammad Ammar Danial Norazmi,**

Department of Mechanical Engineering, Politeknik Sultan Mizan Zainal Abidin, 23000 Dungun Terengganu

**\*Corresponding author E-mail:** surniza@psmza.edu.my

### Abstract

This project is applied from the observation based on the current manual method to reduce the fuel consumption and emissions of today's internal combustion engines. There are various issues that mechanics frequently face when grinding motorcycle valves in the workshop such as trouble installing sand valves and the risk of injuries. Typically, mechanics stand the valve using their hands only. This project aims to design a motorcycle head grind valve machine, fabricate an EZ Grind Valve Machine and analyze its design capability's efficiency. Iron is used exclusively in this project because of its long lifespan and toughness. Additionally, this project integrates human and mechanical systems, which can solve every issue and free up workshop time. The other goal is to prevent air pollution and does not require a large space. The study results found that the time taken for the EZ Grind Valve and manual method to grind the valve is 9.5 and 15 minutes, respectively. It shows that the objectives of this project have been achieved and that it can save time and energy compared to the manual method.

*Key Words: Grind valve; motorcycle; head grind*

### 1. Introduction

The number of motorized vehicles being used for transportation is rising, and with it comes a variety of engine damage. On motorcycles, the most common type of damage is a valve leak in the cylinder head, which is caused by a buildup of crust that forms on the valve seat and obstructs the compression process, decreasing machine performance (Yunani Oksarianti et al., 2011).

The valves, which are located in the engine's head, are in charge of allowing fuel or air to enter the cylinders for combustion (known as intake valves) and allowing the combustion's exhaust to exit the cylinders (known as exhaust valves) (Cooley, n.d.).

The grinding process is widely used to create surfaces with good dimensional accuracy and finish (Moulik et al., 2001). For valves and seals to operate properly, a valve grind also known as a valve job or valve lap may be essential. To fully seal the engine's combustion chamber, the engine valves must be smoothed out for them to properly seal in the valve seat in the cylinder head.

As the vehicle's mileage increases, the valves can be damaged and need repair. This is due to constant movement and engine heat. Due to advances in valve metal technologies, most modern engines will never need a valve grind. However, if there is a problem with the valve, valve seat, valve tappet, or rocker arm, then the cylinder head might need to be removed to fit a new intake or exhaust valve. At this point, the valve may need to be lapped in or have a valve job or grind (O'Connor, 2023).

There were many symptoms of valve damage including:

- Increased fuel consumption
- Engine running rough
- White exhaust smoke

- Chuffing noise from the engine exhaust pipe
- Lack of engine power.

After surveying the motorcycle workshop, it was found that because fitting sand valves takes so long, service centers and workshops struggle with the process. One of the problems that mechanics often face while sanding a valve is the potential for injury. Mechanics usually use their hands to sand the valve. Because it is not necessary to use the tool for an extended amount of time, this method can lower the cost of standing the valve.

The EZ Grind Valve Machine can lower worker risk during the valve sanding procedure at the workshop and workers may focus more intently on their work without being distracted by tools.

## 2. Materials and Methods

The materials used to make the frame were hollow square steel as shown in Figure 1 and sheet mild steel. Using hollow iron has many benefits, including being fireproof, termite- and rust-resistant, rapid during installation, and competitively priced. Additionally, the application or installation process is not too challenging because it is quick and easy, which helps to cut down on labor costs.



**Figure 1:** Hollow square steel



**Figure 2:** AC Motor

Figure 2 above shows the 220-240V AC motor, and it was used to convert the alternating current into mechanical power. The stator and the rotor are the two most important parts of the AC motors. The stator is the stationary part of the motor, and the rotor is the rotating part of the motor. The AC motor may be a single phase or three phase.



**Figure 3:** Speed Controller Switch

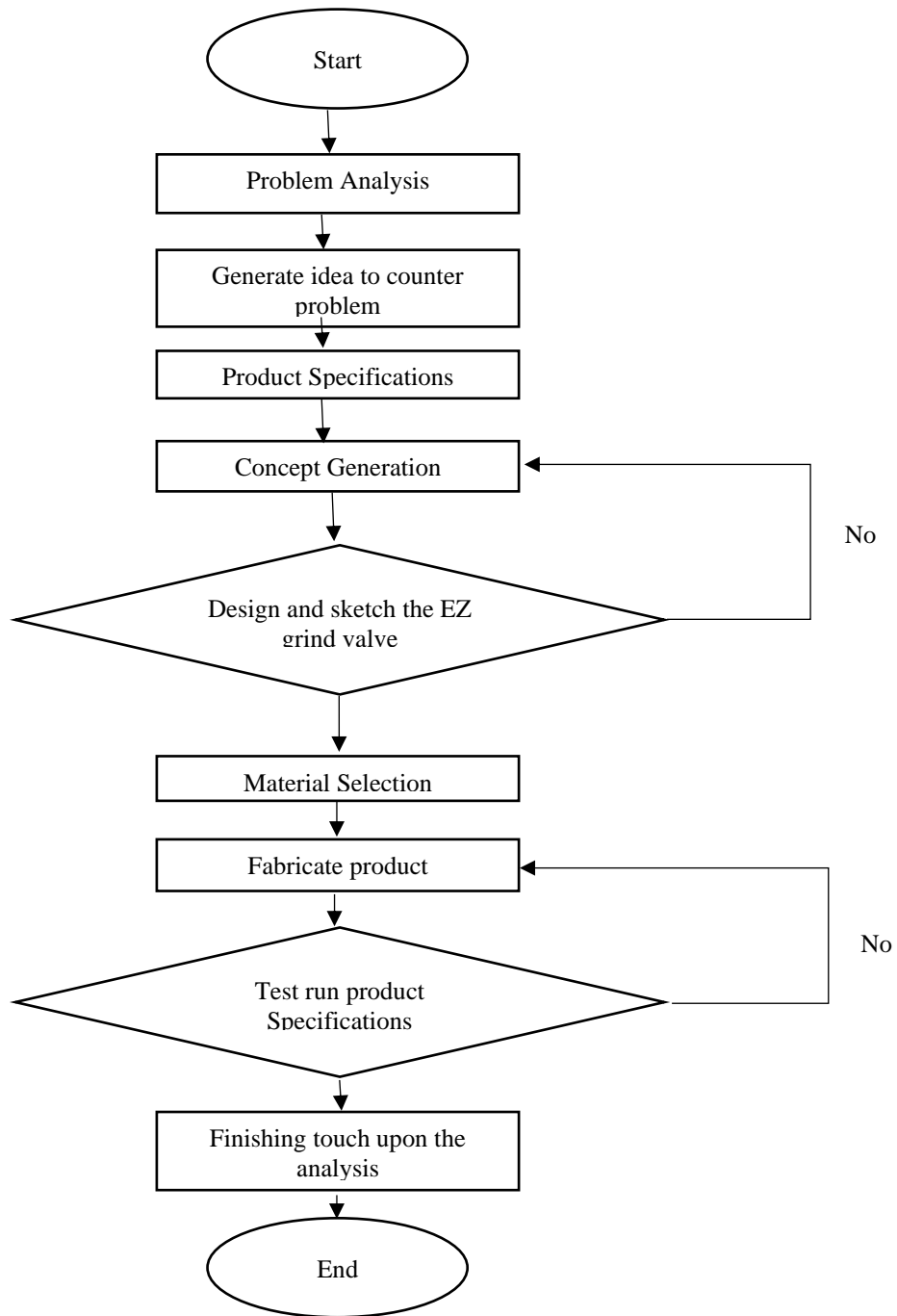
Speed controller switch as shown in Figure 3 is used to control and regulate the speed of an electric motor. It also provides reversing of the motor and dynamic braking.



**Figure 4:** Stand drill

Figure 4 shows stands for drills that were used to hold the electric rotary device securely. The unit can drill up to 13mm into steel and is ideal for a wide variety of applications. Its rigid structure and sturdy design make it a durable choice that requires minimal installation.

The flowchart in Figure 5 shows the process implementation of the EZ Grind Valve Machine. Start by analyzing the problem by collecting information from the workers in the workshop and interviewing some of the mechanics. From that, the idea was generated to counter the problem.



**Figure 5:** Flow chart of Project

### 3. Results and discussions



**Figure 6:** EZ Grind valve

Figure 6 shows the EZ Grind Valve that has been fully assembled. The result of this project is to observe the time taken for the valve to rotate on the motorcycle's head hole.

Table 1 below shows the difference between the method of valve grinding and the time taken to grind the valve. Based on the testing result, it was found that the average time taken for the EZ Grind Valve was 9.5 minutes while for the manual method was 15 minutes. It was proved that the time taken to grind the head cylinder using the EZ Grind Valve is shorter than the manual method. This clearly shows that this project has been successfully produced and works well.

**Table 1:** Method of valve grinding, and time taken to complete the job

Method	1 <sup>st</sup> trial (min)	2 <sup>nd</sup> trial (min)	3 <sup>rd</sup> trial (min)	Average (min)
Manual	20	15	10	15
EZ Valve Grinding	15	8	5.5	9.5

It was proved that by using this machine it can save time and energy by 63.33% compared to manual handling. Moreover, this machine is easy to use and does not require fuel which means it has zero air pollution.

### 4. Conclusion

A valve grind is essential for valves and seals to operate properly. The EZ Grind Valve provides significant and gradual rotation, resulting in time and energy savings compared to the manual method. The study results found that the time taken for the EZ Grind Valve and manual method



to grind the valve is 9.5 and 15 minutes, respectively. It clearly shows that the EZ Grind Valve machine can save time and energy for the user.

## 5. Acknowledgement

The authors would like to praise and thank the Almighty God for giving us the strength and because of His blessing, we finally managed to accomplish this project. Also, we would like to express our gratitude to the Student Project Division and Mechanical Engineering Department, Politeknik Sultan Mizan Zainal Abidin for supporting this project.

## References

- Cooley, B. (n.d.). *Variable valve tech and why your car has it*. CNET. <https://www.cnet.com/roadshow/news/variable-valve-tech-and-what-it-does-in-your-car/>
- O'Connor, M. (2023, July 13). *Engine Valve Grinding/Lapping | Grimmer Motors Hamilton*. Grimmer Motors Hamilton. <https://grimmermotors.co.nz/engine-valve-grinding-hamilton/>
- Moulik, P.N.; Yang, H.T.Y.; Chandrasekar, S. (2001). Simulation of thermal stresses due to grinding. *International Journal of Mechanical Sciences*, v. 43, p. 831-851.
- Yuvani Oksarianti, Mulyono, D., Saputra, R., Saputra, D., Arif, A., & Khairul Kamal, F. (2022). Valve Grinding Automatic System Based Microcontroller. *Spectrum*, 1(01), 19–30. <https://doi.org/10.54482/spectrum.v1i01.100>

# EQ Smart Counter – A Systematic Queue Device for Counter

Noor Azlyn Ab Ghafar\*, Hasliza A Rahim @ Abd Rahim, Nur Alya Naqiah Md Akhir

Department of Electrical Engineering, Politeknik Sultan Mizan Zainal Abidin, 23000 Dungun Terengganu

\*Corresponding author E-mail: noorazlyn@psmza.edu.my

## Abstract

Overcrowding and waiting in line at the service center makes people feel bored and uncomfortable. Example of service centers are government service counters, bank, clinic, post office, airport and so on. Therefore, the purpose of this project is to develop a system named EQ Smart Counter that can help the community to be more productive while waiting in line. Moreover, with the application of the newest technology, which is Internet of Things, this system is eco-friendly and paperless unlike the current queue system. The components used in this project are NodeMCU, DMD P10 board, push button, OLED module. Blynk application is used as a user interface for this project. In conclusion, the development of this project able to help people to be more productive and remove the potential of paper littering.

*Key Words: eco-friendly, NodeMCU, service counter, queue management*

## 1. Introduction

According to Fen (2018), 88% of people surveyed by Telegraph were found that an average of 27 minutes was wasted while waiting in a bank. Consequently, they were very disappointed with the long wait in line (Fen et al., 2018). In addition, based on the analysis done in healthcare service, waiting period of 15 to 30 minutes resulted in frustration of the patient. In Malaysia, according to the research done by Ahmad et. al., in 2018, one to two hours forty five minutes are the average waiting time needed for the outpatient department (Helmy et al., 2021).

Queuing system is defined as a systematic method to manage the sequence of the customer requesting for services (Fen et al., 2018). This type of system is needed for the service provider to efficiently especially for a large number of customers to be entertained on the daily basis. (Jidin et al., 2016; Uddin et al., 2016). In most cases, early morning and during lunch break are the most crowded and peak time for the service sector.

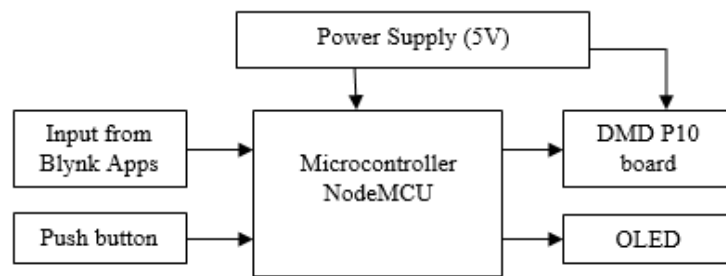
The main problem arising from a long wait in queue is inefficient. The existing system needs customers to sit in the waiting room. Queues, especially in the healthcare sector, are sometimes long and irregular (Agus Mahabojana Dwi Prayoga et al., 2023). This will result in wasting time and being unproductive as time is non-renewable and precious (Dahiru et al., 2022). As a result, customers tend to find another service provider which able to manage their customers more efficiently. In addition, the current system will issue the printed ticket for the customers displaying their waiting number. This may lead to paper littering problem (Jidin et al., 2016). As we moving towards the 17 goals of Sustainable Development Goal introduced by United Nation, littering and recycling are one of the item emphasize for achieving this goal (Durrani, 2019).

To overcome these problems, EQ smart counter is developed. This project's aim is to develop a queuing system using Internet of Things technology that will make the customers more productive in managing their time. This project is also eco-friendly where no ticket will be issued and thus removing the potential for paper littering.

## 2. Methodology

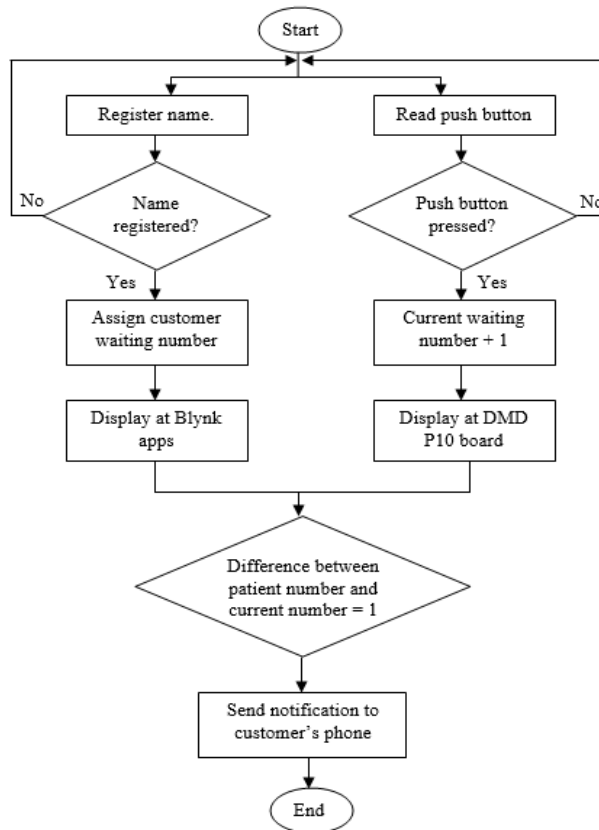
Internet of Things (IoT) is one of the elements in Industrial Revolution 4.0. This technology is defined as communication of things or devices through the internet to serve for specific task (Ariprawira & Kurniawan, 2020). Nowadays, there are many successful companies applied IoT to their system like e-commerce, e-service, e-news and many more (Gamil et al., 2020). As for this project, the EQ smart counter is connected to the internet using WIFI. All the data will be sent to the cloud. Meanwhile, the customer can access the database as the customer's smart phone is also connected to the internet. The application used in this project is Blynk application which can be downloaded from Play Store or Apple store.

Figure 1 below shows the block diagram of this project. This project uses NodeMCU as the microcontroller because it embedded with WIFI module. NodeMCU and DMD board are powered up using 5V power supply. To display the queue number at the service room and counter, DMD P10 board and OLED module are used respectively. Push button is used to increase the queue number. Lastly, Blynk application is for the customer to register their name, display the customer's waiting number and sending the notification. Blynk application is a IoT-base application for mobile phone and widely used because it is free and the interface is user friendly (Dzulkifli & Yahya, 2021).



**Figure 1:** Block diagram of EQ smart counter

The flow of this project is depicted as Figure 2 below. First, the customers need to register their name using Blynk application. Upon registering, the customers will receive their waiting number through the application. Meanwhile, at the counter, the current waiting number will be displayed using DMD board and OLED module. To increase the current waiting number, push button will be pressed. When the difference between the customer's waiting number and current waiting number is one, the user will receive a notification to their phone to alert them that their waiting number is approaching.



**Figure 2:** Flow chart of this project

#### 4. Result and Discussion

Figure 3 below shows the overall hardware and application for this project. As mentioned earlier, the DMD board is used to display the current waiting number in front of the service room. The control box is equipped with push button and OLED module. This control box will be placed at the counter. The current waiting number will be increased when the push button is pressed.



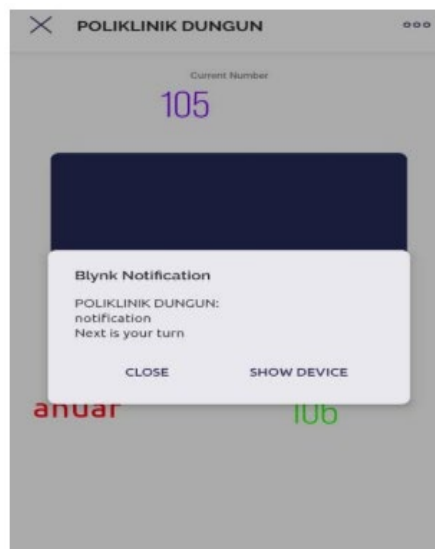
**Figure 3:** Hardware and application of this project

By using the Blynk application, customers need to enter their name so that the customer's waiting number will be generated. Also, the current waiting number will also be displayed in the application. The interface of Blynk application is shown in Figure 3.



**Figure 4:** User interface in Blynk application

While waiting for their waiting number, the customer can sort out their other task rather than waiting without doing anything. When the current waiting number is approaching, the customer will receive the notification shown in Figure 5. With that, the customer can be ready at the service center.



**Figure 5:** Notification in Blynk application

## 5. Conclusion

As we live in a fast-paced world today, we tend to be busy with daily tasks and responsibility. Thus, it is important to manage time efficiently to be productive. Even though nowadays there are many online services available, there are still services that need to be done face-by-face like healthcare, banking and many more. Thus, this project's aim is to make human life easier and more productive. By using this project, customers can settle their other tasks or

responsibilities rather than waiting for queues. Customers need to register their name using the Blynk application to get the waiting number. Once the waiting number and current queue number are approaching, the customers will receive the notification to their smart phone. For improvement, it is suggested that the database system is used so that more details or the customer can be stored.

### Acknowledgement

The authors would like to express gratitude to the Department of Electrical Engineering, Politeknik Sultan Mizan Zainal Abidin, Dungun, Terengganu for the support, opportunity, and guidance in finishing this project. The authors also would like to thank Poliklinik Dr Fetma, Dungun, Terengganu for the support and suggestions for improvement in this project.

### References

- Agus Mahabojana Dwi Prayoga, K., Dika Nugraha, M., Gunantara, N., & Raya Kampus Unud, J. (2023). Digital Queue Prototype at West Denpasar Auxiliary Health Center. *Indonesian Journal of Electrical and Electronics Engineering (INAJEEE)*, 6(2), 10–13. <https://doi.org/10.26740/inajeee.v6n2>
- Ariprawira, G., & Kurniawan, M. A. (2020). Internet of Things Industry in Supporting Industrial Revolution 4.0. *410(Imcete 2019)*, 349–353. <https://doi.org/10.2991/assehr.k.200303.084>
- Dahiru, A. B., Muhammed Halidu, K., & Nduku, S. E. (2022). DESIGN AND DEVELOPMENT OF AN AUTOMATIC PATIENT CALLING SYSTEM FOR HOSPITAL. In *International Journal of Engineering Processing & Safety Research Published by Cambridge Research and Publications IJETR ISSN (Vol. 173, Issue 5)*.
- Durrani, K. (2019). Waste Management and Collaborative Recycling: An SDG Analysis for a Circular Economy. *European Journal of Sustainable Development*, 8(5), 197. <https://doi.org/10.14207/ejsd.2019.v8n5p197>
- Dzulkifli, M. T., & Yahya, R. (2021). IoT-based Child-in-Car Safety Reminder. *Evolution in Electrical and Electronic Engineering*, 2(2), 363–368. <https://doi.org/10.30880/eeee.2021.02.02.043>
- Fen, C. P., Faiz, A., Abidin, Z., Hadi Azahar, A., Zaidi, M., Tumari, M., Ali, N. M., Karis, M. S., Kadiran, K. A., & Adam, A. (2018). The Development of the Queue Management System that Prioritize Handicapped Person.
- Gamil, Y., A. Abdullah, M., Abd Rahman, I., & Asad, M. M. (2020). Internet of things in construction industry revolution 4.0: Recent trends and challenges in the Malaysian context. *Journal of Engineering, Design and Technology*, 18(5), 1091–1102. <https://doi.org/10.1108/JEDT-06-2019-0164>
- Helmy, M., Wahab, A., Tun, U., & Onn Malaysia, H. (2021). Smart Counter Monitoring System with Internet of Things Izzah Fadz. <https://www.researchgate.net/publication/373632853>
- Jidin, A. Z., Yusof, N. M., & Sutikno, T. (2016). Arduino based paperless queue management system. *Telkomnika (Telecommunication Computing Electronics and Control)*, 14(3), 839–845. <https://doi.org/10.12928/TELKOMNIKA.v14i3.3114>
- Uddin, M. N., Rashid, M., Mostafa, M., Salam, S., Nithe, N., & Ahmed, S. Z. (2016). Automated Queue Management System. In *Type: Double Blind Peer Reviewed International Research Journal Publisher: Global Journals Inc (Vol. 16)*. <http://creativecommons.org>.

## Gas Tank Weight Scale

Wee Siuw Sia\*, Muhammad Najmi Bin Mohd Zawawi

Department of Electrical Engineering, Politeknik Sultan Mizan Zainal Abidin, 23000 Dungun Terengganu

\*Corresponding author E-mail: siuwsia@psmza.edu.my

### Abstrak

*Gas Tank Weight Scale* merupakan alat penimbang tong gas L P G (*Liquid Petroleum Gas*) yang dapat menyukat kuantiti gas LPG dengan tepat. Alat ini sesuai digunakan di kedai makan dan rumah. Dengan adanya alat penimbang itu, masalah seperti kehabisan gas ketika memasak dapat dielakkan. Selain itu, alat ini juga dilengkapi dengan sistem pengesan kebocoran gas. Kebelakangan ini, banyak kes letupan gas berlaku kerana kebocoran gas yang tidak disedari sehingga mengorbankan nyawa. *Gas Tank Weight Scale* direka sebagai satu inisiatif yang baharu kepada penjual dan orang awam sebagai satu alat untuk mengetahui kuantiti gas dalam tong dengan memaparkan berat tong gas pada LCD. Selain itu, LED digunakan sebagai penunjuk kuantiti gas di dalam tong. *Gas Tank Weight Scale* menggunakan mikrokawalan Arduino, *load cell*, alat pengesan kebocoran gas dan beberapa komponen elektronik lain. Rekabentuk projek ini menggunakan besi yang kukuh untuk meletak tong gas dan saiz alat penimbang ini ada sesuai untuk diletakkan di dalam kabinet dapur. *Gas Tank Weight Scale* telah diujiguna oleh 5 orang suri rumah dan peniaga. Setelah diujiguna, didapati alat ini dapat membantu peniaga dan suri rumah membuat persediaan awal sebelum gas habis, ini dapat memudahkan kerja memasak mereka. Selain itu, produk ini juga membantu pengguna mengesan kebocoran gas dengan segera, ini dapat mengelak sebarang kemalangan berlaku.

**Kata Kunci:** *Gas LPG, gas weight, LCD, load cell, Arduino*

### 1. Pendahuluan

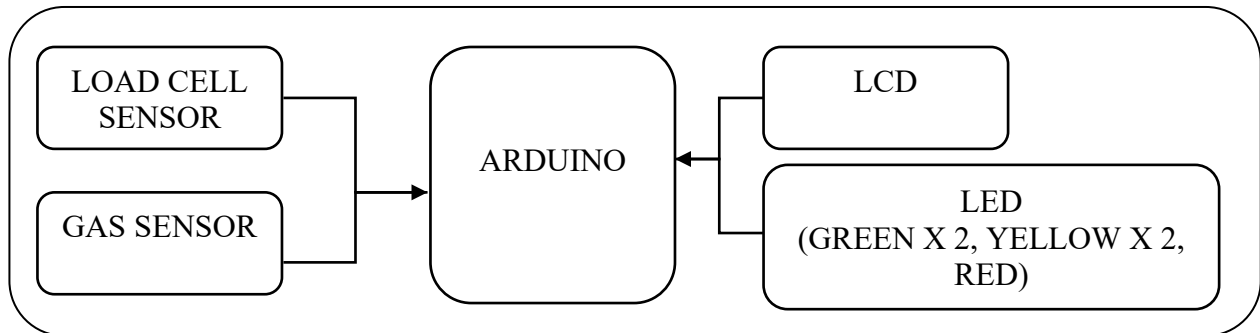
Sejak akhir-akhir ini, acap kali kita melihat berita di televisyen dan dada-dada akhbar tentang kes kebakaran rumah dan kedai makan yang disebabkan kebocoran gas. Isu ini amat membimbangkan semua pihak kerana tanpa sedar kebocoran gas berlaku apabila penghuni tiada di rumah atau kedai makan, kehilangan nyawa dan harta adalah sesuatu yang menyedihkan.

Selain itu, gas memasak tidak disalur secara terus ke dalam kebanyakan rumah di Malaysia. Sebaliknya, kita bergantung kepada tong gas untuk memasak. Masalah utama menggunakan tong gas ialah kesukaran mengagak jumlah gas yang tinggal dan kerap kali gas habis ketika sedang memasak. Suri rumah atau peniaga terpaksa mengambil masa yang lama untuk servis tukar gas datang dan tukar gas baharu. Sekiranya perkara ini berlaku pada waktu malam, maka masalah ini bertambah rumit kerana kebanyakan servis gas telah tutup kedai dan tidak menghantar tong gas lagi.

Dengan ini, *Gas Tank Weight Scale* telah direkacipta untuk memudahkan pengguna menganggar isipadu gas yang ada di dalam tong gas. Isipadu tong gas dapat dilihat pada LCD dan penunjuk LED. Terdapat 5 LED (*Light Emitting Diode*) yang menunjukkan kuantiti gas dalam tong. Sekiranya tong gas penuh, kelima-lima LED akan menyala dan apabila kuantiti gas berkurangan LED akan padam menjadi empat LED dan seterusnya tiga LED, dua LED dan LED merah bernyala bermakna gas berada pada tahap kritikal. Dengan menggunakan produk ini, suri rumah dapat menganggar kuantiti gas dalam dengan mudah.

## 2. Kaedah Kajian

Selain itu *Gas Tank Weight Scale* direka dalam bentuk saiz yang sesuai dengan tong gas yang ada di pasaran dan dapat dimasukkan ke dalam kabinet almari dapur. Rajah 1 menunjukkan gambarajah blok *Gas Tank Weight Scale* yang menunjukkan sensor sebagai masukan dan LCD serta LED sebagai keluaran bagi produk ini.

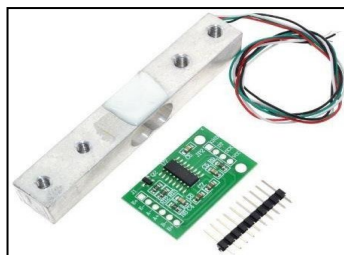


**Rajah 1:** Gambarajah Blok *Gas Tank Weight Scale*

## 3. Perkakasan Gas Tank Weight Scale

Beberapa komponen elektronik digunakan dalam pembangunan litar *Gas Tank Weight Scale*. Antara perkakasan yang digunakan adalah sensor HX711 module, pengesan gas MQ2, LCD, Arduino UNO dan LED.

### 3.1 Sensor Loadcell HX711 Module



**Rajah 2:** Sensor Loadcell HX711 Module

Rajah 2 menunjukkan sensor Load Cell HX711 Module yang digunakan dalam *Gas Tank Weight Scale*. Produk ini menggunakan 4 biji sensor Load Cell HX711 Module. Sensor Load Cell HX711 Module adalah jenis sensor beban yang banyak digunakan untuk mengubah beban atau gaya menjadi perubahan tegangan listrik. Perubahan tegangan listrik tergantung dari tekanan yang berasal dari beban.

### 3.2 Pengesan Gas MQ2

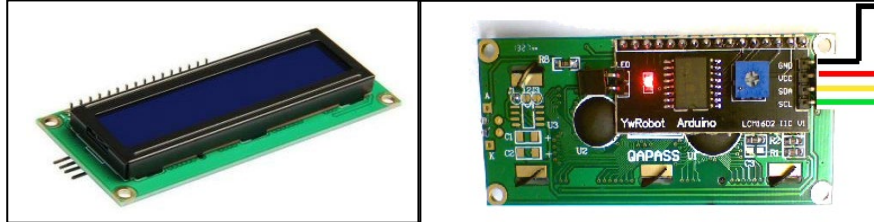


**Rajah 3:** Sensor Gas MQ2



Rajah 3 menunjukkan sensor Gas MQ2. Sensor ini merupakan sensor yang sensitif pada gas methane, butane, LPG dan asap. MQ2 berfungsi menggunakan pemanas kecil di dalamnya bersama sama sensor elektro-kimia serta sesuai digunakan dalam bilik. Keluaran sensor gas MQ2 ini adalah isyarat analog dan boleh dibaca dengan *input analog Arduino*.

### 3.3 LCD with I2C



**Rajah 4:** LCD with I2C

Rajah 4 menunjukkan bahagian depan dan belakang LCD 16 x 2 yang telah disambungkan dengan module I2C. Module berwarna hitam yang ditunjukkan dalam gamabrasah adalah Module I2C yang boleh digunakan untuk berbagai jenis Size Screen LCD. Dengan menggunakan module ini, hanya sambungkan pin SDA dan pin SCL Module I2C ini pada pin A4 dan pin A5 Arduino UNO yang merupakan Port I2C. LCD merupakan skrin yang sesuai untuk membuat paparan huruf atau abjad seperti memaparkan bacaan sensor atau memberi notifikasi pada pengguna.

### 3.4 LED



**Rajah 5:** LED

Rajah menunjukkan LED yang digunakan dalam *Gas Tank Weight Scale*. Produk ini menggunakan 5 LED, 2 LED hijau, 2 LED kuning dan 1 LED merah untuk memberi indikator kepada pengguna tentang kuantiti gas di dalam tong gas.

### 3.5 Arduino Uno



**Rajah 6:** Arduino Uno

Rajah 6 menunjukkan pengawal mikro Arduino Uno yang digunakan dalam produk ini. Arduino Uno merupakan papan pengawal mikro berdasarkan ATmega328P. Arduino Uno mempunyai 14 pin input/output digital, 6 input analog, sambungan USB, port ICSP dan butang set semula. Arduino Uno dapat menerima isyarat yang dihantar oleh sensor,

memproses isyarat dan memberi arahan kepada LED dan LCD berdasarkan pengaturcaraan yang telah upload ke dalam Arduino UNO. Pengaturcaraan yang digunakan ialah Arduino IDE.

#### 4. Dapatan dan Analisa

##### 4.1 Produk *Gas Tank Weight Scale*



**Rajah 7:** Produk *Gas Tank Weight Scale*

Rajah 7 menunjukkan produk *Gas Tank Weight Scale* yang telah siap dihasilkan. Pengguna boleh meletakkan tong gas di atas alat penimbang dan bacaan isipadu gas akan tertera pada LCD.

##### 4.2 Ujiguna dan Analisis

Selepas *Gas Tank Weight Scale* siap, produk diuji untuk mengetahui fungsi produk melalui berat dan isipadu gas. Di Malaysia terdapat 2 jenis berat gas yang biasa digunakan iaitu 12 kg dan 14 kg. Oleh itu, bacaan yang dipaparkan pada LCD dan LED bergantung kepada berat gas yang digunakan oleh pengguna. Berat tong gas dikira mengikut formula di bawah.

**Jadual 1:** Contoh pengiraan bagi tong gas 14 kg.

Berat Tong Kosong	16.5kg
Berat/Isipadu gas	14kg
<b>Berat Bersih</b>	<b>30.5kg</b>

**Jadual 2:** Nyalaan LED mengikut berat gas dan peratus gas di dalam tong gas 12 kg

Bacaan berat gas (tong gas dan isipadu gas) (kg)	Peratus gas pada LCD	LED menyala mengikut berat
15.8 – 18.2	< 20%	Merah
18.3 – 20.6	< 40%	Kuning
20.6 – 23.0	< 60%	Kuning
23.0 – 25.4	< 80%	Hijau
25.4 – 27.8	< 100%	Hijau

**Jadual 3:** Nyalaan LED mengikut berat gas dan peratus gas di dalam tong gas 14 kg

Bacaan berat gas (tong gas dan isipadu gas) (kg) (kg)	Percentage gas pada LCD	LED menyala mengikut berat
16.5 – 19.3	< 20%	Merah
19.3 – 22.1	< 40%	Kuning
22.1 – 24.9	< 60%	Kuning
24.9 – 27.7	< 80%	Hijau
27.7 – 30.5	< 100%	Hijau

Mengikut ujikaji yang dijalankan, terdapat ralat pembetulan bagi setiap ujikaji yang dijalankankan iaitu sebanyak 4%.

## 5. Kesimpulan

*Gas Tank Weight Scale* telah diujikaji oleh 5 orang suri rumah dan peniaga. Soal selidik telah diedarkan kepada pengguna. Terdapat 2 aspek yang ditanya kepada pengguna, iaitu rekabentuk produk dan fungsi *Gas Tank Weight Scale*. Didapati pengguna berminat dan suka akan *Gas Tank Weight Scale*. Jadual di bawah menunjukkan penilaian pengguna terhadap rekabentuk *Gas Tank Weight Scale*.

**Jadual 4:** Penilaian Terhadap Rekabentuk *Gas Tank Weight Scale*

No	Item	Tahap			
		Sangat Tidak Setuju	Tidak Setuju	Setuju	Sangat Setuju
1	Adakah <i>Gas Tank Weight Scale</i> mudah digunakan?	0	0	1	4
2	Adakah saiz <i>Gas Tank Weight Scale</i> sesuai digunakan?	0	0	0	5
3	Adakah bahan yang digunakan untuk membuat <i>Gas Tank Weight Scale</i> sesuai?	0	0	0	5
4	Adakah <i>Gas Tank Weight Scale</i> tahan lasak?	0	0	1	4
5	Adakah <i>Gas Tank Weight Scale</i> menarik minat anda untuk membeli?	0	0	0	5

Jadual 4 menunjukkan penilaian pengguna terhadap reka bentuk *Gas Tank Weight Scale*. Keputusan senarai semak penilaian produk menunjukkan bahawa semua pengguna bersetuju dengan reka bentuk *Gas Tank Weight Scale*. Selain itu, semua pengguna bersetuju bahawa *Gas Tank Weight Scale* mudah digunakan, tetapi mereka berasa agak sukar kerana memerlukan bekalan kuasa untuk mengendalikannya. Semua pengguna berminat untuk memiliki *Gas Tank Weight Scale* kerana ia banyak membantu mereka dalam mengetahui kapasiti gas di dalam tong.

**Jadual 5:** Penilaian Terhadap Fungsi *Gas Tank Weight Scale*

No	Item	Level			
		VD	NA	A	VA
1	Membantu pengguna membuat persediaan awal sebelum kehabisan gas	0	0	1	4
2	Memudahkan kerja memasak	0	0	0	5
3	Membantu pengguna mengetahui kapasiti gas	0	0	0	5
4	Pengesan yang digunakan sesuai	0	0	1	4
5	Alat ini mesra pengguna	0	0	0	5

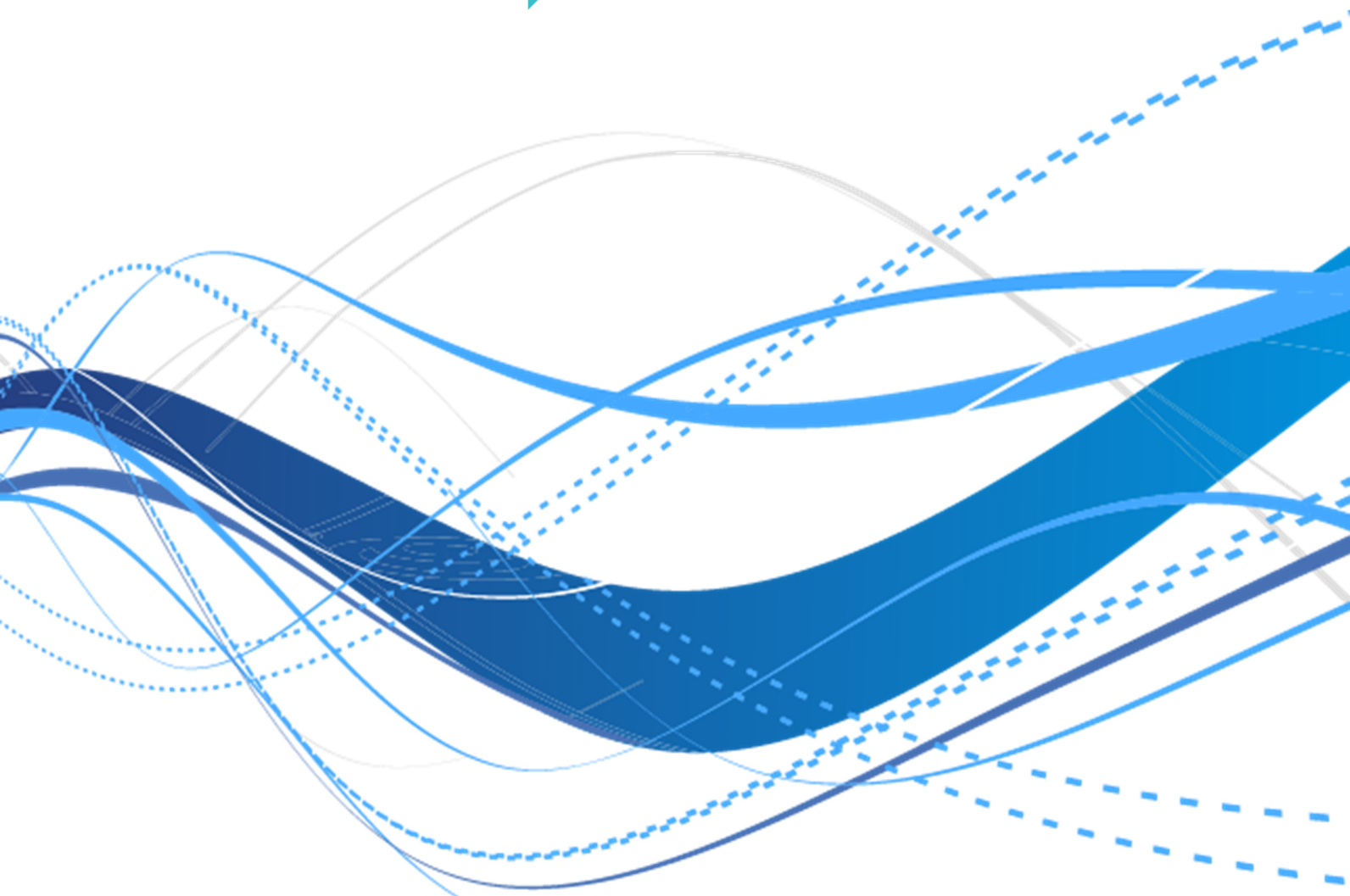
Setelah diujiguna, didapati alat ini dapat membantu peniaga dan suri rumah membuat persediaan awal sebelum gas habis, ini dapat memudahkan kerja memasak mereka. Selain itu, produk ini juga membantu pengguna mengesan kebocoran gas dengan segera, ini dapat mengelak sebarang kemalangan berlaku.

### Rujukan

- Akif, I. (2018). Servis Penghantaran Gas Memasak Petronas ke Rumah. Retrieved from <https://www.akifimtiyaz.com/2018/03/servis-penghantaran-gas-memasak.html>
- Attia, H. A., & Ali, H. Y. (2016). Electronic Design of Liquefied Petroleum Gas Leakage Monitoring, Alarm, and Protection System Based on Discrete Components. *International Journal of Applied Engineering Research*, 11(19), 9721-9726.
- Effi,S. (2015). Gas Scale : Penimbang Pintar Mengesan Jumlah Gas Di Dalam Tong Gas Dengan Pengesan Kebocoran Terbina. Retrieved from <https://amanz.my/201584057/>.
- Fire and Rescue Department Malaysia. (2018). Laporan tahunan 2018. Retrieved from [https://www.bomba.gov.my/bomba/resources/user\\_1/UploadFile/Penerbitan/BOMBA\\_2018.pdf](https://www.bomba.gov.my/bomba/resources/user_1/UploadFile/Penerbitan/BOMBA_2018.pdf)
- Punch newspaper 2021, Panic as gas leakage occurs in Ikeja. Available at <https://punchng.com/breaking-panic-as-gas-leakage-occurs-in-ikeja> retrived January 17, 2021.
- Rachmad Hidayatullah dan Husnibes Muchtar, Jurusan Teknik Elektro Fakultas Teknik Universitas Muhammadiyah Jakarta, êLEKTUM, Vol.11, No.2, November 2015 (2015), Robot Pendeteksi Kebocoran Gas Menggunakan Mikrokontroller Atmega 328 Dan Sensor Gas MQ6”
- Saddam (2017, March). Arduino Weight Measurement using Load Cell and HX711 Module.<https://circuitdigest.com/microcontroller-projects/arduino-weight-measurement-using-load-cell>.

STUDENT'S PROJECT COMPETITION INNOVATION AND INVENTION DESIGN

 **PEED**



ISSN 2990-904X



9 772990 904002